

SWISSPEARL ARCHITECTURE #23

AT THE WATERFRONT

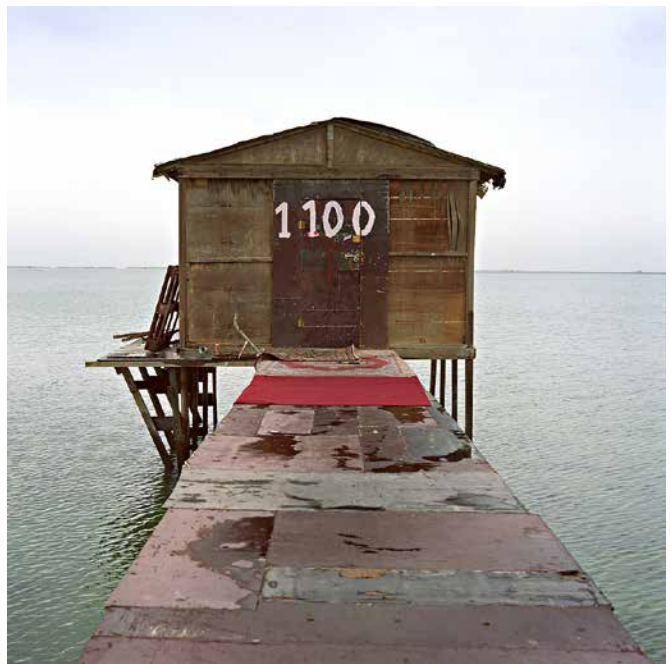



EDITORIAL

Looking at water is fascinating; after all, a natural theater is revealed. Water follows its natural circulation and remains in constant motion. Sunlight is refracted in multifold ways on the surface. Depending on the time of day and weather, the water's movement and waves, the reflections glimmer, glitter, or sparkle. The view over an ocean or a lake across to the other shore evokes a sense of expanse that we associate with openness and freedom. It stirs memories of beach holidays, ship voyages, and sailing trips.

A building that has a view of water brings its inhabitants in touch with nature. Architecture encounters water not only in swimming pools, boathouses, and dockyards. For public venues and cultural facilities, locations at the edge of the water are favorite choices. Residential buildings produce an intimate reference to water. Shoreline properties and coastal cliffs are among the preferred residential locations, and structures there are frequently densely compacted.

In their architectural designs, buildings on water often refer to maritime building forms. The ship motif, in particular, has a solid tradition in modern architecture. Rounded and pointed volumes, railings like those found on a ship, and superstructures such as command bridges are common ship metaphors. Elsewhere, the waveform is transformed onto the building's silhouette, the façade exterior, or other elements of the design. Sometimes the coloring alone refers to the nearby water.

This edition of *Swisspearl Architecture* shows, on the basis of several examples, how building at the waterfront with cement composite takes place. The architectural historian Rahel Hartmann Schweizer provides an account of how building at the waterfront has changed over the course of history. And the architect and urban planner Kees Christiaanse talks about the transformation and development of harbor cities against the backdrop of his own designs.

Wishing you much insight and pleasure with our magazine

Michael Hanak, Editor

Left: "Coastal Promenade" by the Lebanese artist Camille Zakharia, taken in 2010 along the coastline of Bahrain.

AT THE WATERFRONT

Report by Rahel Hartmann Schweizer

2 COVERED BRIDGES, FISHERMEN'S PERCHES, AND HULLS

Norway
Narud Stokke Wiig, Oslo

6 KYSTENS HUS, TROMSØ

Canada
Patkau Architects, Vancouver

12 TULA HOUSE

Australia
Idle Architecture, Richmond

20 RESIDENCE, JAN JUC, VICTORIA

Switzerland
Müller Architekten, Ipsach

25 RESIDENTIAL HOUSES BELLA VISTA, TWANN-TÜSCHERTZ

Switzerland
Neff Neumann, Zurich

28 RESIDENTIAL BUILDING, MEILEN

Norway
LEADinc., Husnes, and Rambøll Norge as, Fyllingsdalen

35 CULTURAL CENTER, HUSNES

Croatia
Sangrad d. o. o., Zagreb

38 SWIMMING CENTRE VIJUŠ, SLAVONSKI BROD

Portugal
Tiago Castro, Viana do Castelo

44 SAILING CENTER, VIANA DO CASTELO

Essay by Kees Christiaanse

50 THE WATERFRONT AS VANGUARD FOR A SUSTAINABLE URBAN FUTURE

EMBOSSEMENT

56 HOUSE OF RELIGIONS, BERN, SWITZERLAND

ENGRAVING

60 JOPLIN HIGH SCHOOL / FRANKLIN TECHNOLOGY CENTER, JOPLIN (MO), USA



6



12



25



44

COVERED BRIDGES, FISHERMEN'S PERCHES, AND HULLS

Report by Rahel Hartmann Schweizer



Ponte Vecchio in Florence, built 1345, photo ca. 1952.

Right: Swimming pool in Bellinzona, Switzerland, 1968–1970 by Aurelio Galfetti, Flora Ruchat-Roncati, and Ivo Trümpy.

Nowadays, building on the water is normally a lucrative affair, but that was not always the case. Wastewater was once emptied into lakes and rivers; floods devastated the land and destroyed crops. The only people to settle close to the shore were those whose trades, and later industries, relied on water: first fishermen, tanners, dyers, millers, then factories. Industry and sales were initially housed under one roof in a special type of covered-bridge construction, and later, the water-power was used.

One of the most famous covered bridges is Ponte Vecchio in Florence. Now the bridge is mainly used to sell jewelry; it was also originally dominated by tradespersons—primarily butchers and tanners. The former tossed their foul smelling animal waste in the Arno; the latter used the river to wash the leather goods that they had previously tanned with horse urine. Due to the odor, Cosimo I de' Medici ordered goldsmiths to settle the area in 1565.

Also covered was the Weir Bridge, built in 1915/16, of the hydraulic power plant in Eglisau on the Rhine, which first delivered electricity in 1920. In order to provide the factory team a roof for protection from the weather, the walkway was furnished with a shelter running down its entire length. Its construction comprised a light iron shell and walls of cement composite panels.

The modern water supply system freed commercial operations from their reliance on lake access; industries no longer had to depend solely on naturally flowing water. For the mains, pipes made of cement composite were used. Rivers and lakes then became attractive as residential areas and for leisure use. Apart from villas, also beaches and temporary entertainment facilities for exhibitions, cinemas, and theaters emerged.

Covered bridges

Covered bridges experienced a revival as tourist attractions. They not only achieved the rank of landmarks, such as Ponte Vecchio in Florence (1345) and Rialto in Venice (1588–1591), but were also role models for contemporary architectural designs. Bernhard Tschumi and Luca Merlini reverted to the model in 1989 in their successful competition draft for the redesigning of the Flon quarter in Lausanne: the valley floor, through which the eponymous river once flowed, was drained in the nineteenth century. Tschumi and Merlini developed a concept of skywalks fitted with buildings and planned to fill them with various cultural and commercial uses.

The bridge-shaped pedestrian skywalks built over the swimming pool in Bellinzona (1968–1970) became iconic. However, they were not covered above, but rather below the concrete panels mounted at a height of six meters. The architects Aurelio Galfetti, Flora Ruchat-Roncati, and Ivo Trümpy placed the cabins and changing rooms on an intermediary level three meters above the ground, connected to the pedestrian level by means of ramps and stairs. Contrasting the compactness of the viaduct, they chose a light steel construction, which they furnished with Thermolux glass and cement composite.

Stilt houses and tents

The gaze at the life of fishermen also changed with the dawning of the modern era. Bernard Rudofsky, who focused on the quality of vernacular building, presented in his book *Architecture without Architects* (1964), among other concepts, a spectacular fisherman's perch in Italy's Vieste. The house on Lake Murten built by Werner





Allenbach in 1945, seems as though a similar fisherman's perch had been used as model.

In the six-cornered summer pavilion on Hoover Lake in Westerville, Columbus (OH) built in 1962, Pierre Zoelly united the elevated track on six telephone poles in excellent stilt-house quality, with a tent-like covering to shield the glazing. He covered the outer, bowl-shaped wall, which combined the soffit with the balustrade, in cement composite.

The desired optical lightness at the Swiss exhibition for women's work (SAFFA) in 1958 on Lake Zurich, was also achieved with cement composite. The exhibition's architect Annemarie Hubacher-Constam chose a double roofing of slate to cover the chapel as though with a large tent.

The undulating roofscape of the entry to the Zurich garden show (Züga), which Karl Egender and Wilhelm Müller designed in 1933 together with the landscape designer Gustav Ammann, plays with the proximity to water, too. The same can be said for the halls, the majority of which are reminiscent of hangars or dockyards, which were uniformly clad with corrugated cement composite panels and glass. But the architects did not leave it at the metaphoric reference alone. The journal *Schweizerische Bauzeitung* from September 2, 1933 raved about the beautiful "effect of these glass surfaces, from which the rainwater [...] ran off the silver-gray, shimmering cement composite panels."

Futuristic backdrops

Construction on the water thus became its own topos—antithetical as it were to building in the mountains. In 1919, in the publication *Alpine Architektur*, Bruno Taut devised fantasies on the water and drew them on sketch sheets, such as "Weg zum Kristallhaus am Wildbachtal" or "Tal mit reicher Architektur."

The structures published by the auto manufacturer Ford and the electronics firm Motorola in the 1960s as backdrops for their products were fantastical, or rather futuristic, in an entirely different way. Ford's magazine *Ford Times*, which the company published monthly beginning in 1908, featured the designs. The editor selected ten spectacular sites and commissioned the architect Rudy Hermes to design houses that would stage the landscapes. The photographer Charles Harper envisioned

them photo-realistically. Motorola proceeded in a similar way. The company asked the artist and illustrator Charles Schridde to paint a series of houses, which they published in various advertisements as "Houses of the Future." Several of the villas "designed" by Hermes/Harper or by Schridde had a close relationship to water: the villas juttled spectacularly over an ocean cove, ran along the shore of a creek, rose like a light house in tossing surf, swam like stranded flying saucers on top of the water, or in the water as a type of inwardly turned aquarium, or they were designed entirely as underwater boats; with the Tula House (p. 12), completed in 2012, it seems very much as though the architects of today followed from such models.

Ship metaphors

The ship as a reference was propagated by Le Corbusier. The "dom-ino" principle referred to the skeleton of the ship construction, which is essentially based on a spine, keel, frame, and strakes over which a skin of fur, wood, or steel is stretched, and included a deck. With the machine-like version of the ocean liner, he then founded the "living machine." As a result, the ship metaphor reared its head again in several buildings of classical modernism, whereby the real context to water was secondary.

In 1930, Hans Scharoun designed a house on a green meadow for the pasta manufacturer Fritz Schminke; its curved terraces, ramp-like stairways, and round bulls-eye windows stirred associations with a ship.

A beautiful example in sight of the water, with a view of Lake Zurich, is the Villa Streiff in Küsnacht, built by Otto Zollinger in 1929 and renovated in 2012. The ship aesthetics become manifest here mainly in the rounded edges and greatly cantilevered balconies. The Swiss-American architect Otto Kolb tied the metaphorical analogy



Summer house Erlinger near Rust on Lake Neusiedl, Austria, 1958, by Bruno Tinhofer.

Top: Boathouse at the yacht club in Zurich, 1917, by Pflegehard & Häfeli.

Top right: Villa Streiff in Küsnacht, Switzerland, 1929, by Otto Zollinger. Bottom right: single-family home in Villarepos, Switzerland, 2009/10, by Aeby, Aumann, Emery.

with proximity to the water in a villa for the couple Horner in Beverly Shores (1948–1950), a stretch of land formed by dunes on the southern shore of Lake Michigan. Kolb arranged the spatial program as four structural volumes; garage, guest house, as well as sleeping and living areas with veranda. While the garage and guest house stand as individual cubes, the tower-like sleeping wing functions as an anchor for the light wood construction of the living area, as well as the navigating bridge of the house, balancing on the dunes, and in the back, projecting over a lushly overgrown ravine. Whereas Kolb used redwood for all parts of the closed façade, he furnished the window balustrades of the annex with cement composite panels. The material suited Kolb, because on the one hand, it brought an industrial note to the wood structure, which corresponded with the ship motif, and in doing so nonetheless had a “natural” color, that is, one immanent to the material, while on the other hand, it emphasized the lightness of the house. The house sails like a ship through the landscape. The file for the house’s protection as a monument from 1996 states, “The window walls on both north and south elevation, make the floor and ceiling seem to float in the midst of a natural bower.”

The boathouse for the Zurich Yacht Club by Pflughard & Häfeli from 1917 is an actual swimming volume. It consists of six reinforced concrete pontoons, which are covered by a continuous, reinforced concrete panel, and is thus designed as a raft. Whereas the architects used pitch pine for the outer façade, which brings to mind ship’s planks, they clad the interior with cement composite.

In 1958, for the summerhouse Erlinger near Rust on Lake Neusiedl, the Viennese architect Bruno Tinhofer placed the wooden construction on top of an existing base panel anchored on piles in the water. He designed all of the exterior wall surfaces with white cement composite panels. A walkway tied to it seems like the dinghy attached



to the houseboat. In Villarepos, south of Lake Murten, the single-family home built in 2009/10 positively embodies the theme “building on water.” With this structure, the architects Aeby, Aumann, Emery won the architectural prize “Das beste Einfamilienhaus” (The best single-family house) from *Ideales Heim* magazine. Six stripe foundations, designed like the runners of a hydrofoil, anchor the concrete floor panel, and lift it from the terrain, which—in a way, similar to Kolb’s Horner Villa—seems to flow through below. This becomes even more apparent when considering that the architects set the house directly in the meadow without including a design of the surroundings. The cladding of partially perforated, light-gray corrugated cement composite sets it into undulant motion (see *Arch* 157, pp. 29–31). The structure “mimes” as it were, ship and water.

Literature

Rahel Hartmann Schweizer, *Otto Kolb – Architekt und Designer*, Zurich 2013, pp. 202–212. – *National Register of Historic Places*, Horner House, Porter County, Indiana, The Art Institute of Chicago, Chicago 1996, p. 10.





NORWAY

GRANITE ANCHOR

Kystens Hus, Tromsø

LOCATION: Stortorget 1 CLIENT: Norges Råfisklaget – The Norwegian Fishermen's Sales Organization
ARCHITECTS: Narud Stokke Wiig, Oslo (Gudmund Stenseth, partner-in-charge) BUILDING PERIOD: 2014/15
GENERAL CONTRACTOR: Econor AS, Tromsø FAÇADE MATERIAL: Swisspearl® LARGO, CARAT Black Opal 7024R



SCHEFFER

6

This new landmark facility offers a meeting space for diverse interest groups interested in the coastal region, and also seafood production. The permeable, fully glazed ground level is conceived as an extension of the public realm. The center's upper part accommodates office spaces and is clad in a multi-faceted envelope reminiscent of the rock formations lining the northern Norwegian coast.

PATRICK ZAMARIÀN Located in the center of Tromsø, Kystens Hus—the “Coastal Seafood Center in Northern Norway”—is a flagship building showcasing the country’s powerful fishing industry. Envisaged as hub for information and business related to the fisheries, research and development, and tourism the facility’s primary purpose is to showcase the city’s and the wider coastal region’s cultural tradition, natural wealth, and economic drive. More specifically, Kystens Hus seeks to promote the development and marketing of products and services by fostering collaboration and exchange of knowledge among private companies, research institutions, and the general public.

Informal meeting place

True to its public aspiration, the center features a permeable, extensively glazed, and partially double-height ground level, which links up with the surrounding sidewalks through a number of separate doorways as well as two main entrances located in opposite corners of the roughly rectangular plan. The resulting diagonal pathway connects a public square to the southwest of the building with a popular quay promenade to the north, dividing the ground floor itself into two interlocking triangular sections. Incorporating various auxiliary rooms and staircases, the open ground level is conceived as an informal meeting place facilitating a variety of simultaneous uses. In addition to a permanent food hall for local producers and specialty shops, the center offers an exhibition arena for organizations involved in research and education. The plan centers upon a large, light-flooded atrium, which features a sweeping staircase that extends the public space to the level above. Meeting the narrower business aspect of the facility, the four upper floors accommodate concentric layers of office spaces and conference rooms accessed by suspended skywalks that provide a visual connection to the ground-floor lobby.

Multi-faceted envelope

Oslo-based architects Narud Stokke Wiig sought to design a new gravitational center

for the city, giving it a distinctive look without disrupting the formal unity of its surroundings. Substantially larger than the neighboring timber structures, the 12,500 square-meter facility obtains a certain lightness by seemingly hovering above the fully glazed lower section. More importantly, the irregular contours of the façade break the scale of the building whilst maximizing the inflow of natural light and offering spectacular views of the marina and the mainland area of the city. Clad in highly insulated, charcoal-colored Swisspearl panels, the envelope is composed of twenty-three faceted surfaces, allowing it to respond to the characteristic features of the urban context—exuberant on the waterfront, more restrained to the rear where the building helps to clarify the streetscape. Shape and coloring of the building recall the rugged granite cliffs of the Norwegian coast, reflecting the building’s core aspiration of providing a link between tradition and technology, past and future.

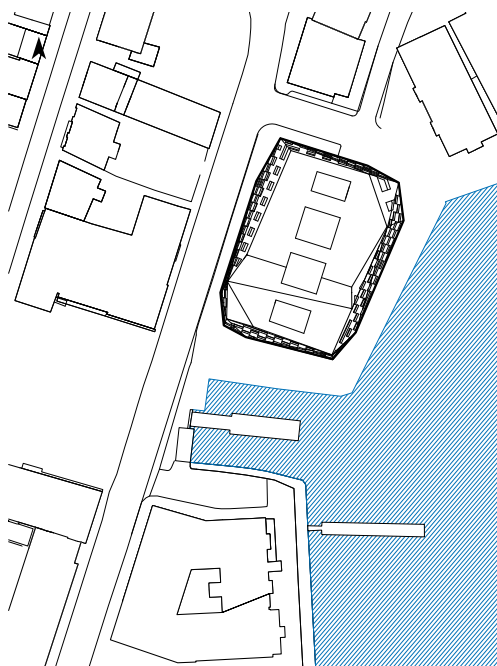





“We intended to shape a building with a unique expression that takes into account the existing qualities of the surrounding areas, but simultaneously defines a new gravitational center for the city.”

Narud Stokke Wiig, architects

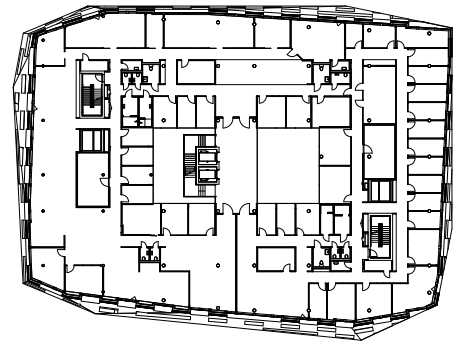

Fourth floor

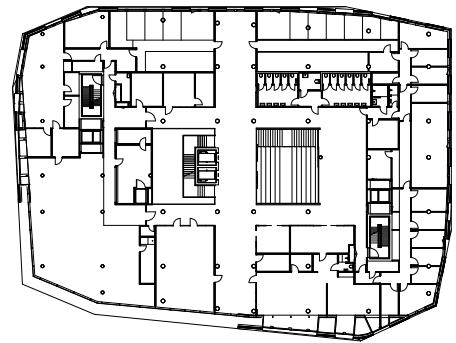

Second floor

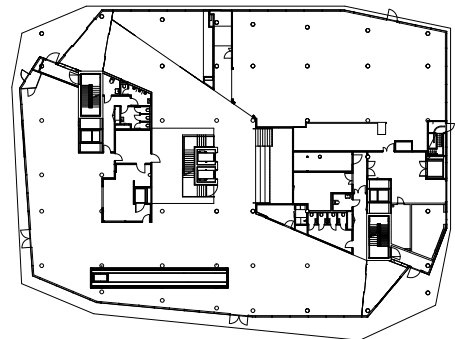

First floor 1:1000

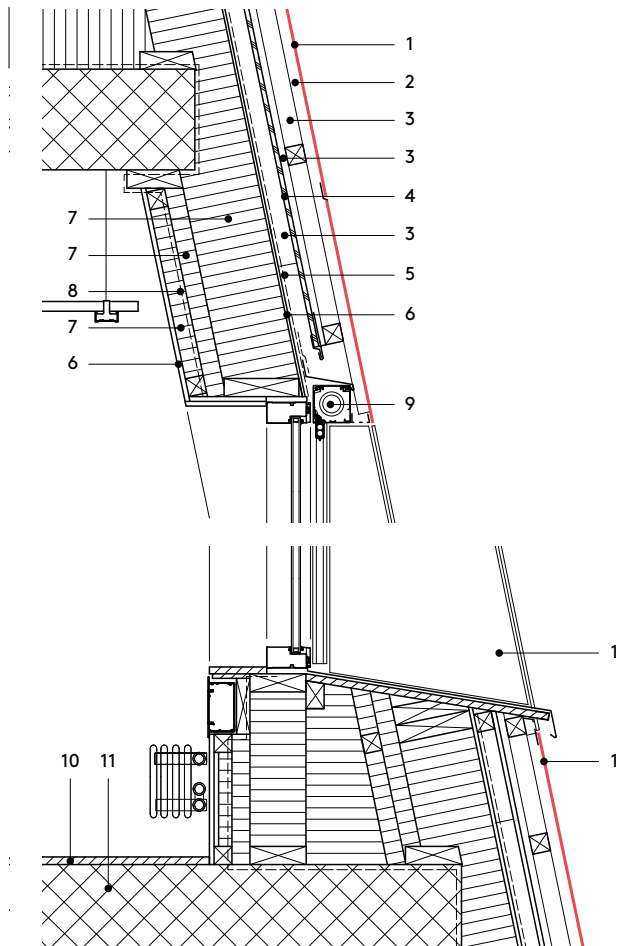

Vertical section 1:20

- 1 Swisspearl® LARGO panel 8 mm with R-color coating
- 2 ventilation cavity, vertical timber batten
- 3 timber batten
- 4 plywood board
- 5 moisture barrier
- 6 gypsum plaster board
- 7 thermal insulation
- 8 vapour barrier
- 9 roller blinds
- 10 wooden floor
- 11 concrete

CANADA
FLOTSAM

Tula House

LOCATION: Quadra Island CLIENT: Eric Peterson & Christina Munck, Quadra Island

ARCHITECTS: Patkau Architects, Vancouver BUILDING PERIOD: 2007–2012

GENERAL CONTRACTOR AND FAÇADE CONSTRUCTION: J.Toelle Construction Ltd., Quathiaski Cove

FAÇADE MATERIAL: Swisspearl® LARGO, CARAT Black Opal 7025









“The building reflects the irregularity of the land’s rock ledges, beach, and forest in both its geometric and spatial order.”

John Patkau, architect



On a wild coastal stretch of Canada's Quadra Island, Patkau Architects have built an extraordinary single family house that blends into the island's natural environment while at the same time perfectly showcasing its rough beauty. The sea and its tidal impacts served as inspiration for the carefully designed layout and shape of the structure.

MIRKO BEETSCHEN It must be every architect's dream project: to be commissioned for a house on a unique site in a remote natural setting and to enjoy the client's full trust. "Aside from requiring a simple list of spaces, the client left the development of the house completely up to us," architect John Patkau says. The owners of a dilapidated cottage on the eastern coast of Quadra Island wanted "an architecturally designed house that responds sensitively to the rich and varied setting," he continues. Besides a dwelling for themselves, the house, nearly six hours north of Vancouver, was also to become the informal headquarters for the couple's Tula foundation, a family organization that serves as patron to healthcare and environmental initiatives.

Quadra Island is the largest of the Discovery Islands, situated northwest of Vancouver in the waters between Vancouver Island and the mainland. The more than 26,000-square-meter plot encompasses a stretch of rocky shore with the actual building site on top of a thirteen-meter-high cliff that is surrounded by an archetypal Canadian landscape full of moss-covered basalt hills, red alder, maple and—predominantly—Douglas fir trees. "The topography of the site is highly irregular," Patkau explains. "One site is actually many sites. The building reflects the irregularity of the land's rock ledges, beach and forest in both its geometric and spatial order."

Back to square one

Before the actual construction began, the derelict cottage was torn down, the previous fill-ups were cleared away, and the natural terrain exposed. Building on this original situation, the architects organized the one-story house as a series of shard-like concrete plates spiraling around a central courtyard like a seashell. Another inspiration for this arrangement and the shape of the house was the debris washed on the shore below, the natural flotsam and jetsam of the Pacific's tides that leave logs, branches, and rocks behind "like a child's game of pickup sticks," as the architects describe it.

The overall structure is concrete, only the roof and cantilevered floor—jutting over the rocky beach and the ocean below—are steel-framed. The day rooms are placed here, along the south and east sides of the house, the fully glazed fronts offering unrestricted views of the water, the islands on the Strait of Georgia, and the mainland of British Columbia with its distant mountain ranges. On the other side, toward the north, lie the bed- and bathrooms, enjoying peaceful prospects of the green basalt hills in the back.

Blending in

Even though Patkau Architects make a bold statement with their Tula House, the 420-square-meter, one-story building is carefully woven into the landscape. Architecture and nature, interior and outside blend. The main spaces fan out around the courtyard to capture the generous water views, while the secondary rooms focus on singular elements in the variegated landscape, like a moss-covered rock or a swath of trees. Shafts of natural light enter the building through narrow skylights, and the cantilevered part even features triangular floor windows, through which one can see the beach and ocean below. The building's main theme—water—also appears in a shallow pool of groundwater within the courtyard.

On the outside, the concrete and framed walls are clad in Swisspearl panels. "The reason we chose cement composite," says architect John Patkau, "in addition to its technical characteristics, was that we needed a monolithic material that could be arrayed overlappingly. We wanted to create a serrated wall profile that would show the animated character of sun and shade on the building surface." The charcoal color together with the moss-covered roof helps merge the cliff-top house into its environment. Along with the native vegetation that the architects and owners replanted, the new structure today all but disappears within the dark woods and rocks.

Long experience

Spouses Patricia and John Patkau founded their architectural office in 1978. Today, the Vancouver-based company is co-headed by partners Greg Boothroyd and David Shone. Patkau Architects have made an international name for themselves through many award-winning projects on various scales, from private homes to large public facilities. A notable project was a series of cottages at the site of Frank Lloyd Wright's famous Fallingwater House in Pennsylvania. Current work includes an art complex for the University of Manitoba, the Polygon Gallery in North Vancouver, as well as various residential projects. "As the circumstances of the work change, our interests expand," the architects write about their work. And: "We refuse singular definitions of architecture: as art, as technology, as social service, as environmental agent, as political statement. We embrace all these definitions, together, as part of the rich, complex and vital discipline that we believe architecture to be."

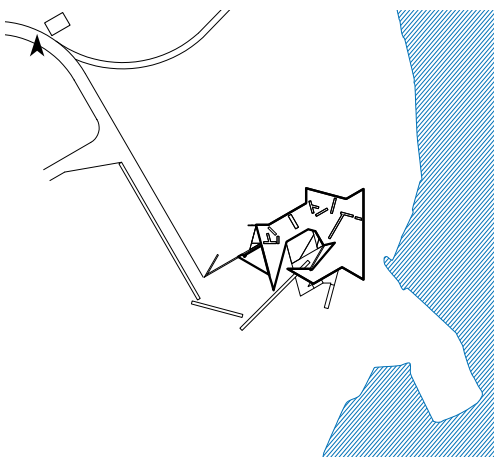

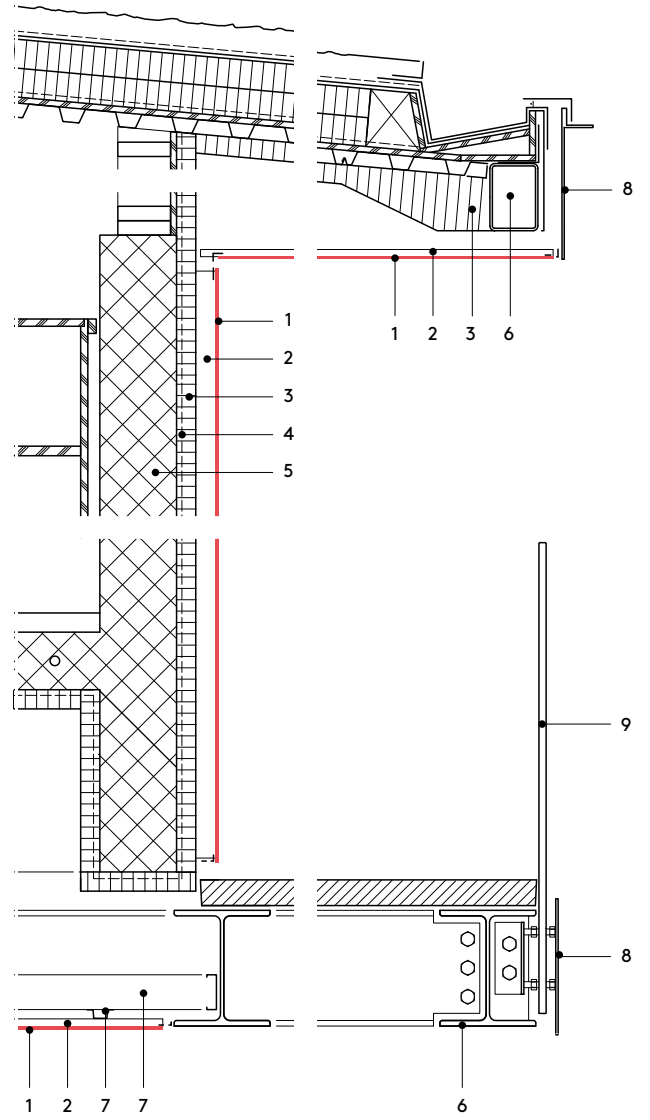
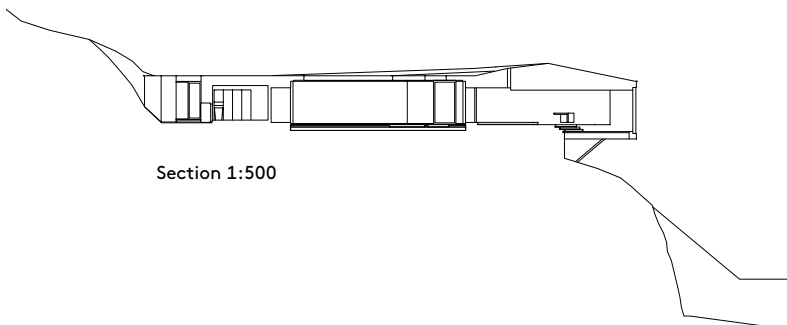
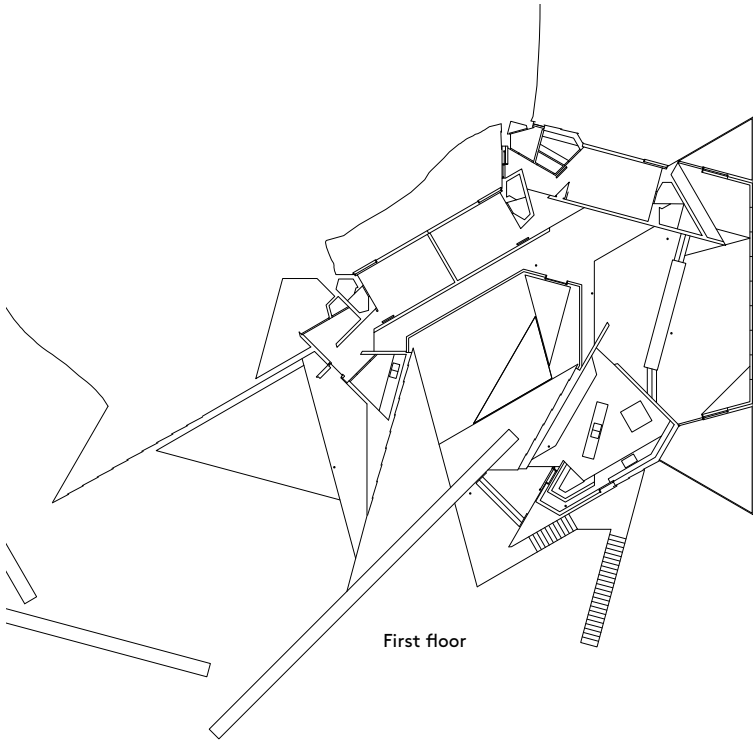

Vertical section 1:20

- 1 Swisspearl® LARGO panel 8 mm
- 2 ventilation cavity, sub framing
- 3 thermal insulation
- 4 vapor barrier
- 5 concrete
- 6 steel beam
- 7 sub framing
- 8 sheet aluminum
- 9 glazed balustrade

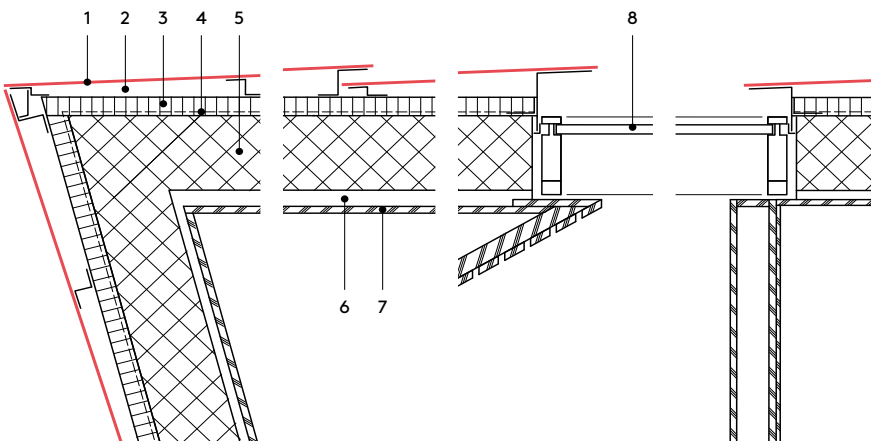

Horizontal section 1:20

- 1 Swisspearl® LARGO panel 8 mm
- 2 ventilation cavity, vertical sub framing
- 3 thermal insulation
- 4 vapor barrier
- 5 concrete
- 6 sub framing
- 7 wooden board
- 8 aluminum window





AUSTRALIA

SLEEPING ON THE COMMAND BRIDGE

Residence, Jan Juc, Victoria

LOCATION: Jan Juc CLIENT: Tim Norris ARCHITECTS: Idle Architecture, Richmond BUILDING PERIOD: 2012/13
GENERAL CONTRACTOR: Maatsuyker Construction, Belmont FAÇADE CONSTRUCTION: Maatsuyker Construction, Belmont
FAÇADE MATERIAL: Swisspearl® LARGO, XPRESSIV Dark Grey 8220 and Light Grey 8060

PATRICK ZAMARIÀN Situated on a hill facing southwest near the south Pacific coast, this family home offers extensive ocean views from each of its rooms. The plan centers upon a large elevated living and dining area equipped with full length glazing toward the seafront as well as the rear-side pool area, allowing the latter to benefit from northern sunlight whilst providing vistas of the sea and sheltering it from the harsh coastal winds.

Meeting the client's wish for minimal maintenance, Idle Architects combined a variety of façade materials that will not necessitate additional coatings. Swisspearl panels in two shades of grey are used toward the pool deck

as well as for the two bedroom wings on either side of the communal area. Emphasized by its dark grey cladding, the upper-floor parents' quarters on the western side appear to float above the remainder of the building, commanding spectacular views of the nearby coast. The single-story children's wing to the east follows the natural slope of the plot and features alternating dark and light grey panels that accentuate its sawtooth shape, resulting from a series of bedroom windows tilted outward toward the sea.

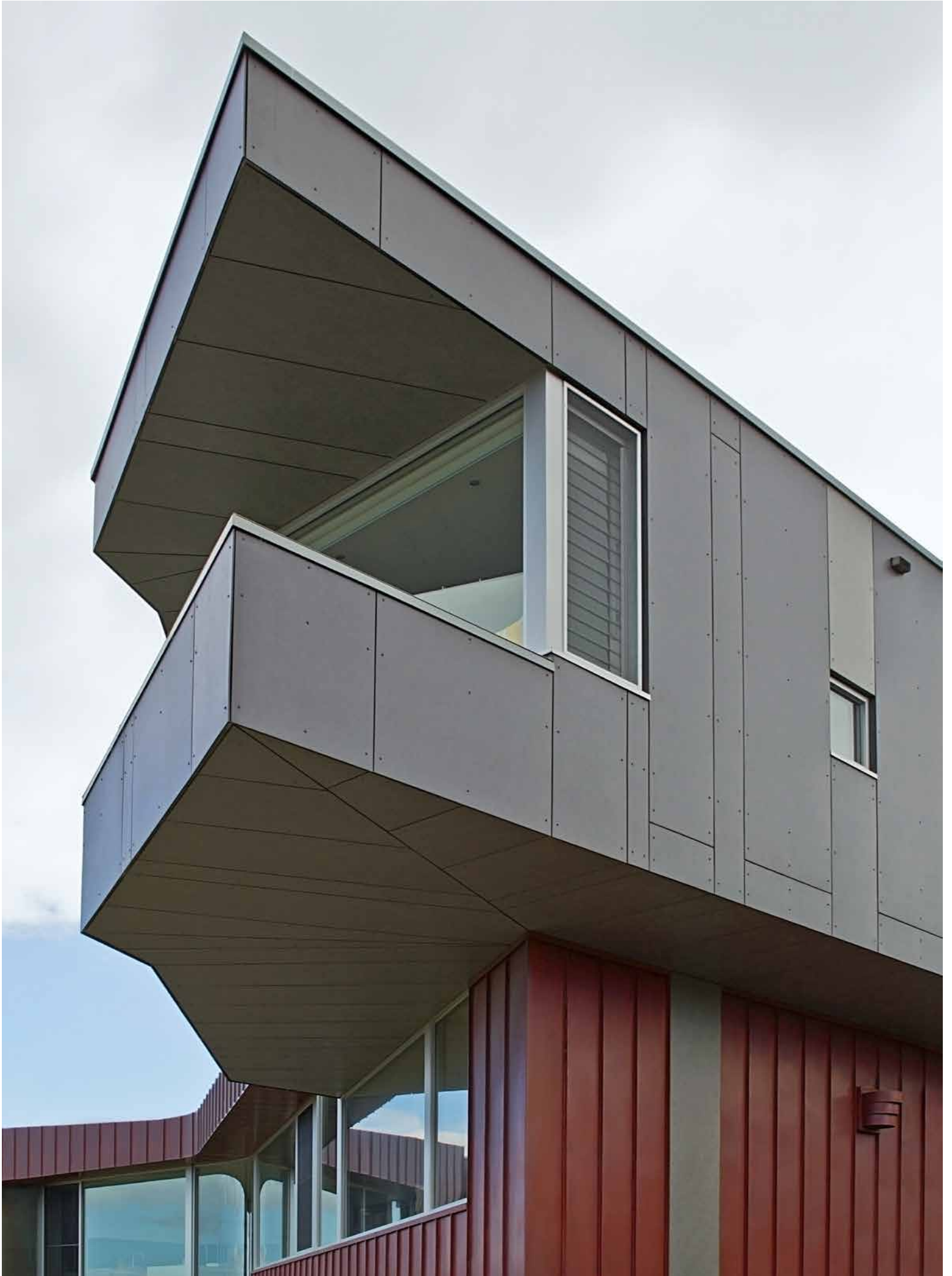

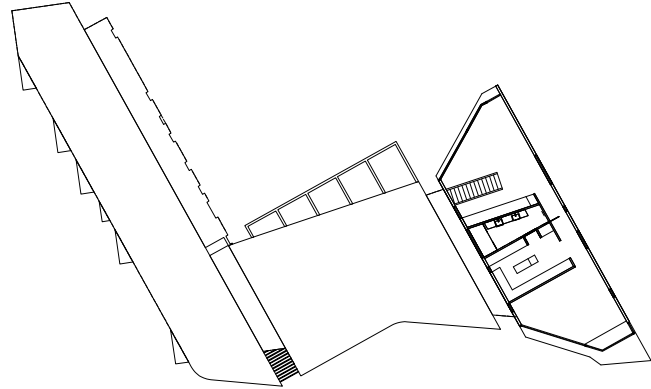
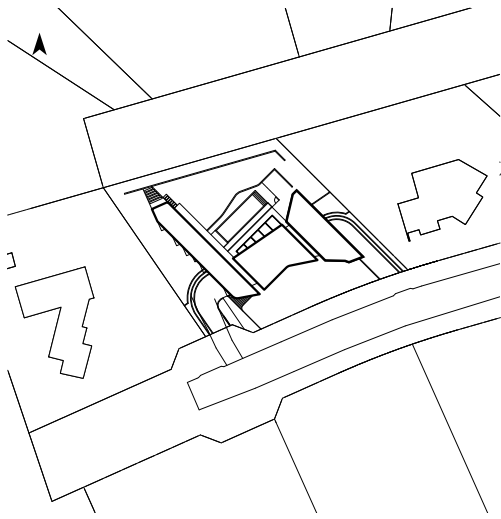

Second floor

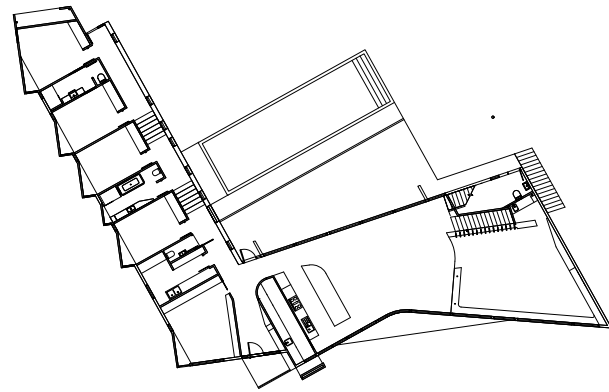

First floor 1:500

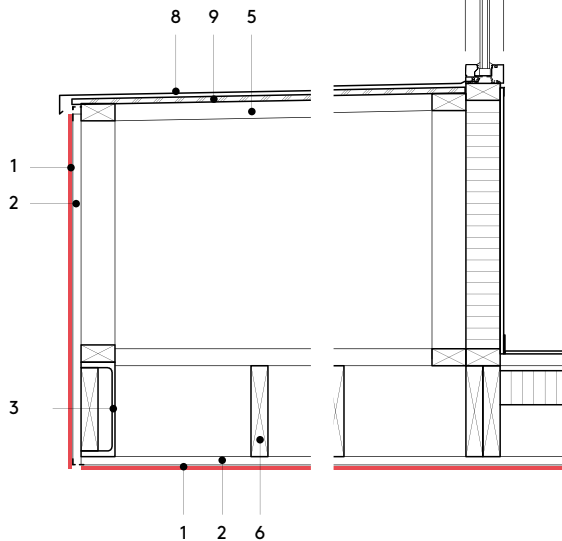
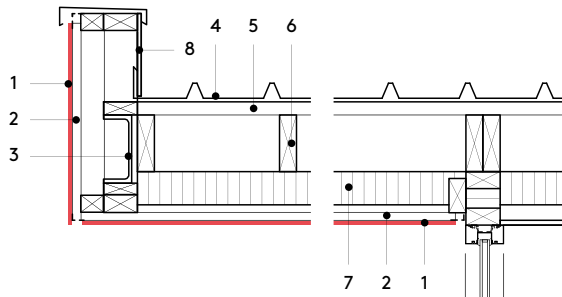

Vertical section 1:20

- 1 Swisspearl® LARGO panel 8 mm
- 2 ventilation cavity
- 3 steel beam
- 4 corrugated metal decking
- 5 batten
- 6 timber rafter
- 7 thermal insulation
- 8 metal sheet
- 9 plywood board



Windows in different dimensions and forms provide panoramic views of the Pacific.



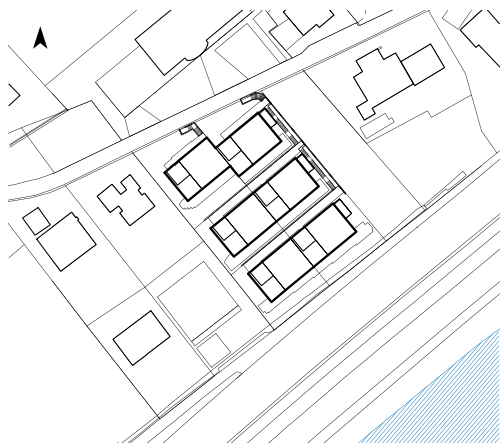



SWITZERLAND
LAKE IN SIGHT

Residential Houses Bella Vista, Twann-Tüschertz

LOCATION: Gaichstrasse CLIENT: Casa e Vita AG, Biel ARCHITECTS: Müller Architekten AG, Ipsach
BUILDING PERIOD: 2012–2014 GENERAL CONTRACTOR: Bielersee Immobilien, Biel FAÇADE CONSTRUCTION: Studer & Cie., Schüpfen
FAÇADE MATERIAL: Swisspearl® LARGO, NOBILIS Grey N 212 and N 213; Swisspearl® INTEGRAL PLAN, NOBILIS Grey N 214R

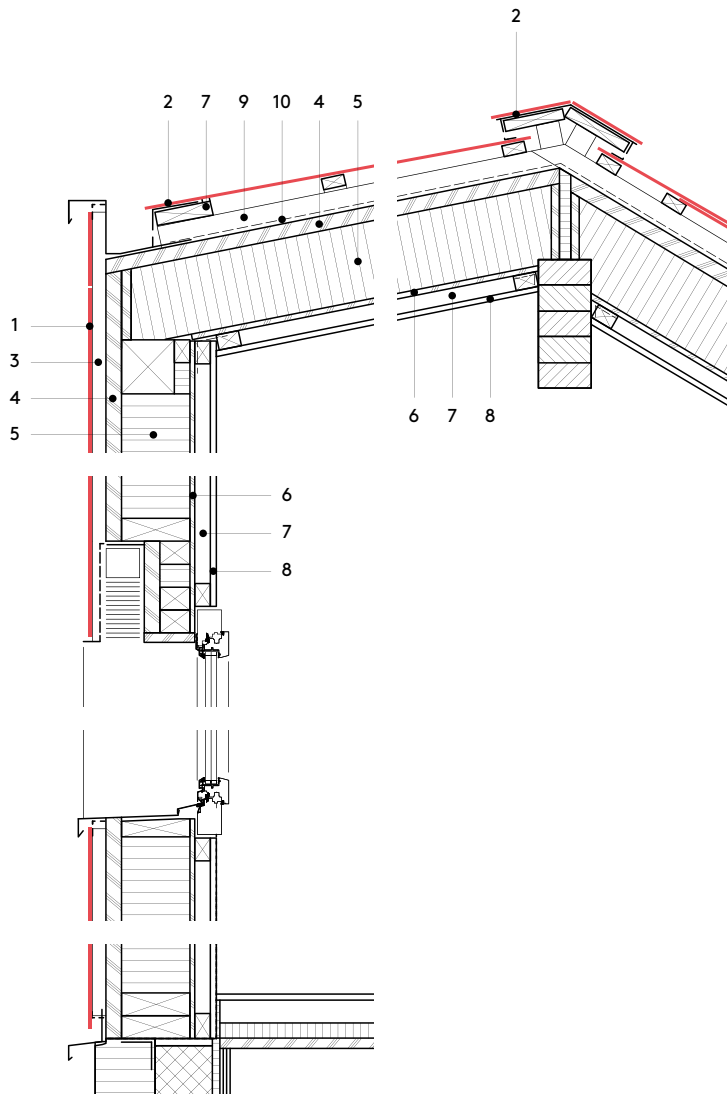

Vertical section 1:20

- 1 Swisspearl® LARGO panel 8 mm
- 2 Swisspearl® INTEGRAL PLAN panel 8 mm
- 3 ventilation cavity, vertical sheeting
- 4 wood fiberboard
- 5 thermal insulation, fiberglass
- 6 oriented strand board
- 7 sheeting
- 8 gypsum board
- 9 counter batten
- 10 membrane

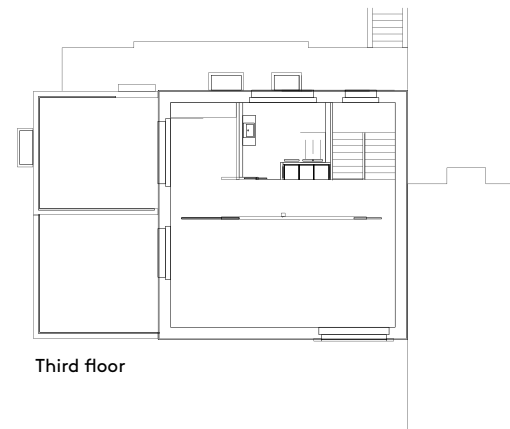

Third floor



Second floor

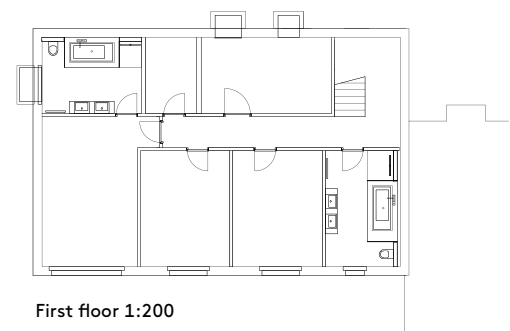

First floor 1:200



ANNA ROOS A new ensemble of houses has recently been built on the northern banks of the Lake of Biel; three rows of twin houses cascade down the steep slope. Due to the topography of the site, each unit is afforded panoramic views across the lake and beyond to the Alpine peaks. In cross section, the Minergie Standard houses are deeply embedded into the steep incline. Although the houses are three stories high, their volume has been visually minimized by restricting the Swisspearl cladding to the two upper levels. The façades of the bedrooms on the lowest level are plastered and painted in a contrasting light buttery-yellow tone. With a subtle gradation of color from soft beige to light grey, the cement composite panels transition seamlessly from wall to roof. The deftly integrated gutter and clipped eaves emphasize the volume's abstract impression. Fenestration on the front façade is reduced to two expressive windows. A large elongated window in the living space, juxtaposed with a cheeky popup dormer window soak up the lake views.

SWITZERLAND

LIVING IN A BOATHOUSE

Residential building, Meilen

LOCATION: Dollikerstrasse 1–7 CLIENT: Baugenossenschaft Zurlinden, Zurich ARCHITECTS: Neff Neumann, Zurich

BUILDING PERIOD: 2012–2014 FAÇADE CONSTRUCTION: Salm Fassadenbau AG, Schinznach-Dorf

FAÇADE MATERIAL: Swisspearl® CORRUGATED PANEL green (special color)





An extremely deep building volume on Lake Zurich takes up the themes of light and water. Neff Neumann Architekten stage the volume of twenty-five living units with a green, corrugated façade and a ceramic mosaic shimmering in the courtyards between the homes. The consistent design connects an embedment in the landscape with the density of a metropolis.

SABINE VON FISCHER In a call for bids, the community of Meilen sought a nonprofit developer to take over the building rights for a non-developed property on Dollikerstrasse in Meilen. Of the five applicants, the Baugenossenschaft (cooperative building society) Zurlinden was awarded the commission. The cooperative organized an architecture competition at its own cost. Of the eleven invited participants, the architects Barbara Neff and Bettina Neumann emerged victorious in February 2011 with their project “pāri-daeza,” Persian for “garden of paradise.”

Substituting the name of a project for the names of the architects serves primarily to preserve the anonymity of the participants, but it also always represents the program. Here, it comprises an idyllic residential world that is quasi animated in house and garden by the theme of light and water. With a subtly structured volume, the project reacts to the heterogeneous surroundings on the fringes of the core zone directly opposite the beach meadows in Obermeilen and bordering on the industrial area to the north.

The façade of corrugated cement composite panels in dark blue-green takes up the theme of the garden houses and boathouses in the surroundings and at the same time meets the high ecological demands. The framework conditions for the idyllic residential complex were tight: not only should the rent in the attractive location be around 2,500 francs per month for nearly 100 square meters, but the emissions from the heavily traveled Seestrasse and the distance to be kept from the water of the Innere Dollikerbach, shaped the architectural conditions. The architects were able to reap qualities from the latter in cooperation with the landscape architect Robin Winogrand: since the façade could not exceed the border ascertained by the water protection provisions, a great deal of space remained for trees, bushes, and squares along the streambed, which was left in its natural state. Keeping to the tradition of the quarter, the garden encircles the building. The entrance to the underground parking garage with space for twenty-three cars is inserted nearly invisibly in the corner of the building; this keeps the appearance largely compatible with the quarter.

Safeguarding sustainability

The Baugenossenschaft Zurlinden achieved pioneering work in Meilen also in terms of sustainability—as they had previously done in Zurich with the six-story residential complex in timber construction by pool architects and the exemplary low-

energy renovation of the residential high rise Sihlweid from the 1970s by Harder Haas Partner. As a union of handicraft enterprises, the cooperative is able to induce the use of sustainable building parts in the most direct way possible. Founded in 1923, it is the second oldest of Zurich’s three building cooperatives in which the contractors rather than the tenants are involved and have the right to vote. The cooperative has thereby built elements that were not yet available on the Swiss market: for example, a ventilation element integrated in the window, built thus far into three residential complexes, which the society’s president Urs Frei developed together with the firm FenTech from St. Gallen and sold via his window factory Albrisrieden.

Colors of the sky in the atrium

By virtue of the architects’ ingenuity, twenty-five living units, the majority with three and a half or four and a half rooms have found space on the property, developed with three stories. As a result of the demand to create a maximum number of inexpensive living units, especially the open-space living areas, which are grouped around an atrium, are situated very close together. The architects already drew attention to themselves with atria in the “Rheinresidenz” on St. Albangraben in Basel: There, however, each of the inner courtyards borders only one of the four condominiums, which are piled on top of one another. Time will tell whether or not the neighborly gaze bothers the residents in Meilen.

On the balconies and inside the living units, profiled glass shields the view and again takes up the themes of light and water. The atria perforate the 21.8-meter, extremely deep building volume in such a way that the natural light of the sky is reflected in all colors along the northwestern wall, which is covered in a glass mosaic. The living and kitchen zones meander around the atria and form the center and climax of each living unit.

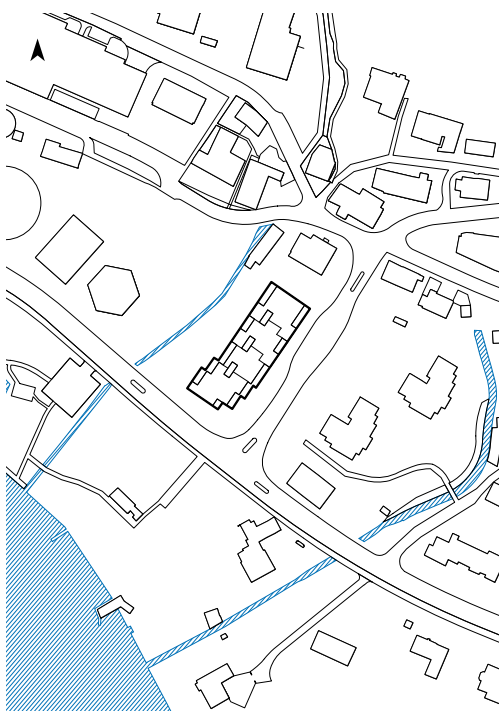



“The material is a reference to structures in garden architecture, and—due to its robustness—utilitarian structures on the lake.”

Neff Neumann Architekten

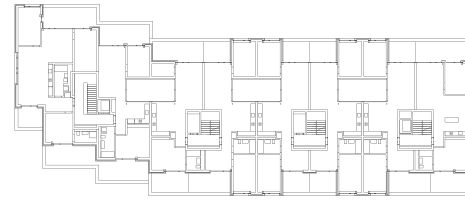

Third floor

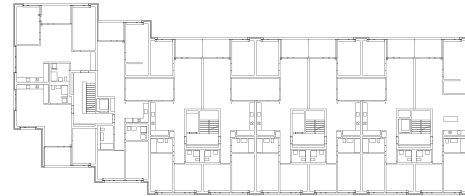

Second floor

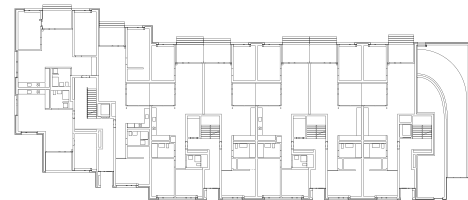

First floor 1:1000

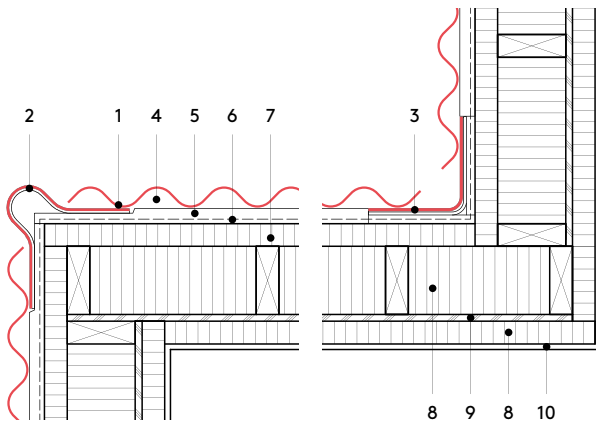

Horizontal section 1:20

- 1 Swisspearl® ONDAPRESS-57 corrugated panel 6.4 mm
- 2 Swisspearl® Corner angle round 6 mm for exterior corners (with inner sleeve)
- 3 Swisspearl® Corner angle smooth 6 mm for inner corners (with inner sleeve)
- 4 ventilation cavity
- 5 horizontal timber batten
- 6 moisture barrier
- 7 soft fiber board
- 8 thermal insulation
- 9 oriented strand board
- 10 glass mat gypsum board

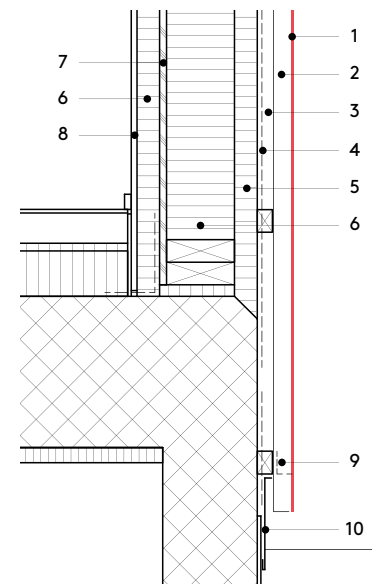

Vertical section 1:20

- 1 Swisspearl® ONDAPRESS-57 corrugated panel 6,4 mm
- 2 ventilation cavity
- 3 horizontal timber batten
- 4 moisture barrier
- 5 soft fiber board
- 6 thermal insulation
- 7 oriented strand board
- 8 glass mat gypsum board
- 9 fly screen
- 10 metal sheet



The living and cooking zones meander around the atria and form the center and climax of each living unit.



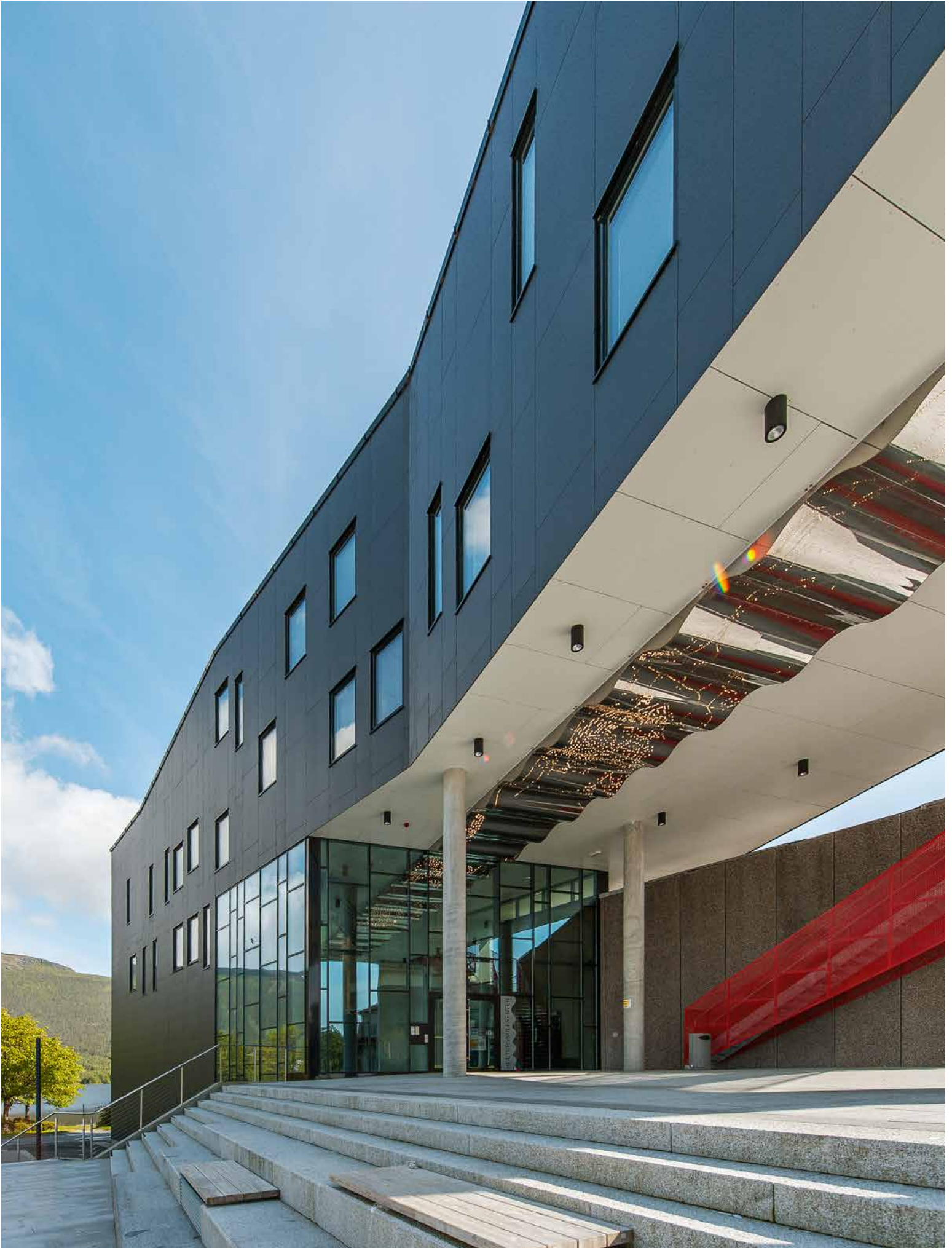

NORWAY

COMPOSITION OF WAVES AND FUGUES

Cultural Center, Husnes

LOCATION: Sentrumsvegen CLIENT: Kvinnherad kommune, Rosendal
 ARCHITECTS: LEADinc., Husnes, and Rambøll Norge as, Fyllingsdalen BUILDING PERIOD: 2012/13
 FAÇADE CONSTRUCTION: Kvinnherad Bygg AS, Seimfoss
 FAÇADE MATERIAL: Swisspearl® LARGO, REFLEX Black Velvet 9221

In a community that arose fifty years ago in the surroundings of an aluminum factory, the architects cover a house in Swisspearl panels. That certainly draws attention. The culture center's panels form a visual art composition.

RAHEL HARTMANN SCHWEIZER The town of Husnes, located on the Hardangerfjorden on the southwestern Atlantic coast, is today's commercial and cultural center of the municipality of Kvinnherad. Already in 2008, it was a talking point with the shopping center completed by Helén & Partner (see *Swisspearl Architecture 12*). Now it has been given a platform once again, and that is meant not only metaphorically. The culture center is equipped with "a world-stage," and the architects quote William Shakespeare's famous passage from *As You Like It* in their project description, "All the world's a stage, and all the men and women merely players: They have their exits and their entrances; and one man in his time plays many parts [...]." When the world is understood as a stage, the architects conclude, then our built environment is the theater of life. Accordingly, they realized their idea of designing every space as a stage of human performance.

Staging of the entrance

The staged moment is apparent already from the exterior. The building volume, kinked in the ground plan and elevation, with the overhanging volume of the dance hall, shields the entrance area, which invites seeing and being seen. The polished, corrugated steel sheet that clads the underside adds an atmospheric charge. During the day, reflections form, alluding to the surface of nearby-Lake Opsangervatnet. At night, LED lights, embedded in an apparently random pattern of perforations, provide a geographic depiction of the region.

By staging the circulation—cloaked externally in red metal mesh; inside, the steps are submerged in red—the architects join a tradition that Russian architect Berthold Lubetkin once described in the beautiful formula, "Any stairway is [by nature] a sort of machine to climb up or to descend, but in the best Beaux arts interpretation, it is a display, it is a dance."

Musical structure

Originally, the architects conceived the shell as a veil, as "aluminum lingerie." But that would have burst the budget, which led them to play off of the optical alternative of the nearby shopping center: using cement composite panels.

Now, culture and commerce converse insofar as the color palette with black panels links seamlessly to the light- and dark-green tones of the shopping mall. Depending on the incidence of light, the façade oscillates in a spectrum ranging from gray to rust-brown, altering the conciseness of the panel alignment. The architects resolved this in a composition that recalls visual performances of musical fugues, for instance, those of Richard Paul Lohse or Heinrich Neugeboren. They worked similarly with most of the window fronts, achieving a complementary expression. This is manifest through light-dark contrasts in a positive-negative game with closed and glazed wall sections and with the visual fugues or the profiles. The interior arrangement transforms the view of the Fjord into a painting of musical fugues and, in reverse, is an external signal of the building's function.

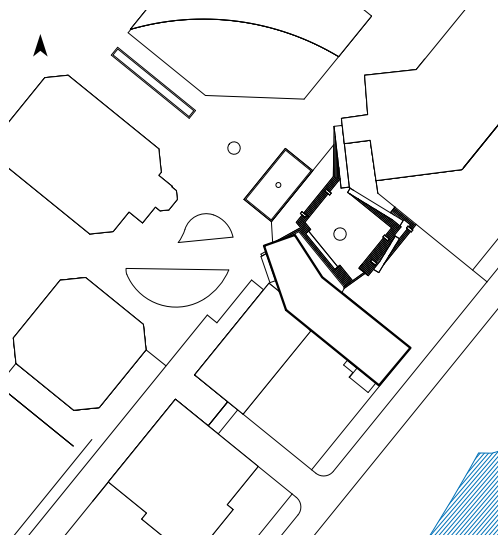

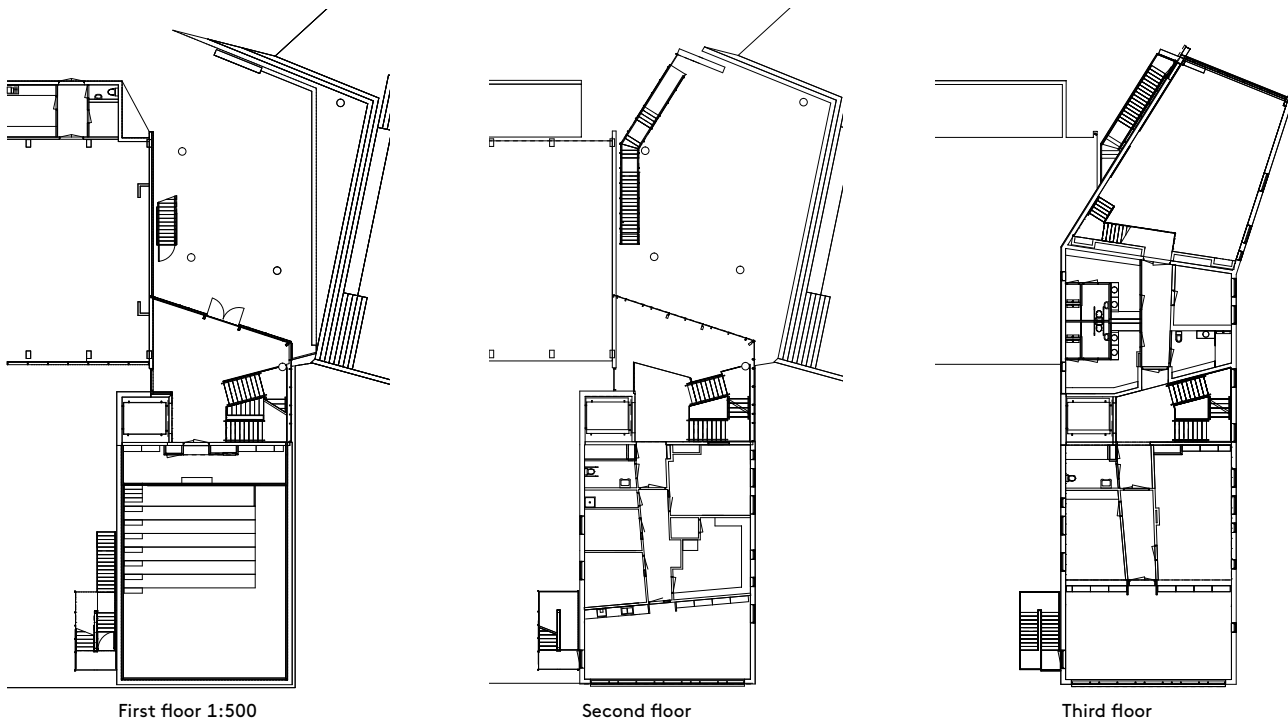

All a stage: from the entrance hall to the open-air amphitheater and above the foyer to the black box of the concert and theater hall; over the exterior gangway, which encloses the dance studio, and the inside stairway through to the classrooms and offices.





The polished, corrugated steel sheet that clads the underside adds an atmospheric charge. During the day, reflections form, alluding to the surface of nearby Lake Opsangervatnet. At night, LED lights, embedded in an apparently random pattern of perforations, provide a geographic depiction of the region.





CROATIA
EXTROVERTED POOLS

Swimming Centre Vijuš, Slavonski Brod

LOCATION: Ul. Stanka Vraza CLIENT: City of Slavonski Brod ARCHITECTS: Sangrad d.o.o., Zagreb BUILDING PERIOD: 2012/13

GENERAL CONTRACTOR: Strabag d.o.o., Zagreb FAÇADE CONSTRUCTION: Imal-Plast d.o.o., Josipovac

FAÇADE MATERIAL: Swisspearl® LARGO, CARAT Black Opal 7022



Architectural office Sangrad from Zagreb received the commission to design a major new sports facility in eastern Croatia. The striking swimming pool building they created on a narrow plot of land between a stadium and a river is a functional and timeless structure that references modernist public baths and brings the natural environment inside.

MIRKO BEETSCHEN Despite its long history—recent findings have revealed that the area of Brod was already inhabited 8,000 years ago—Slavonski Brod’s name is only eighty years

old. Until 1934 the city on the river Sava in eastern Croatia was called Brod na Savi—“brod” originally meaning “ford,” in modern Croatian “bridge.” Brod’s famous fortress is one of the most well preserved in Europe and shows the former strategically important location of the city. The fortress was built in the Baroque period, during the Austro-Hungarian rule, as a bulwark against the Ottoman Empire on the other side of the river.

Closed to one side ...

This important historic building is a point of reference for the architects of a new swimming center when talking about their design.

The city had commissioned Zagreb-based Sangrad architects with the task of building a new swimming center on a triangular plot of land, bordered by the river Sava to the southwest and a large sports stadium to the north. “We derived the architectural concept from this restricted spatial situation, but also from the proximity of the river,” says Vedran Pedišić of Sangrad architects. The building they proposed is an oblong structure along the northern side of the triangle, leaving the open piece of land to the river free. Towards the north and the neighboring stadium the swimming center appears almost completely closed. “It has the form of a bastion here,” the



“With our swimming center we wanted to create a balance between the required program and the natural surroundings, in this case the river Sava.”

Vedran Pedišić, architect





The building is completely closed to the north and west, while opening-up with fully glazed fronts towards the outdoor pool and the river.

architect explains, “a reference to the city’s world-famous fortress.”

...open to the other

On the other side, towards the river, though, it opens up through fully glazed fronts and connects the inside and outside spaces. “We wanted to make a total connection with the environment,” Pedišić adds. Inside, all the necessary service rooms for a swimming center, including changing rooms, showers, and saunas, were positioned on the northern side. This left the planners free to completely open up the actual pool area on the other side. “The pools are extroverted,”

in the words of the architects. Through the fully glazed fronts, swimmers enjoy an unrestricted view of the river’s banks and water. The large windows with their elegant steel-frame divisions evoke similar modernist structures; the finely paneled wooden ceiling angling up towards the windows emphasizes this connotation. The large inside pool is situated on the ground floor. A generous row of stands serves as connection to the upstairs children’s pool.

The colors of the city

For the cladding of the hybrid construction of steel, concrete, wood, and glass the ar-

chitects opted for Swisspearl’s cement composite panels. “We have used the material on many projects before, and we were always happy with the results,” Pedišić says. “The swimming center was to have a ventilated façade, and the Swisspearl panels were the perfect choice for us.” Not only the structure’s technical qualities and the cost-effective solution it supplied were convincing; one of Swisspearl’s colors (Black Opal 7022) even turned out to be the very color of the city emblem of Slavonski Brod.

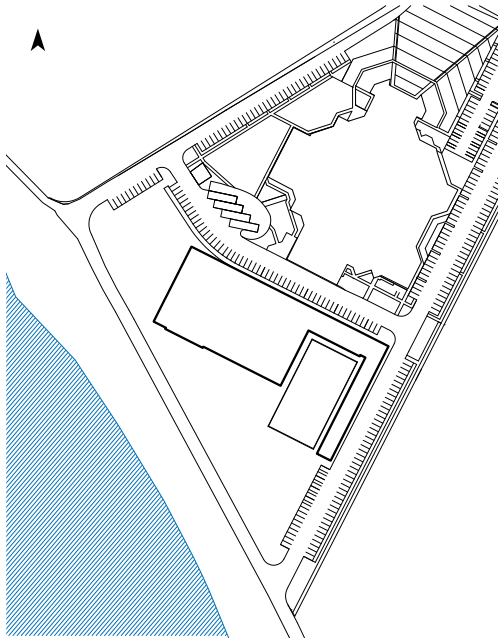

“The Swisspearl panels were not only the best technical and cost-effective solution, they even came with the very color of the city’s emblem.”

Vedran Pedišić, architect

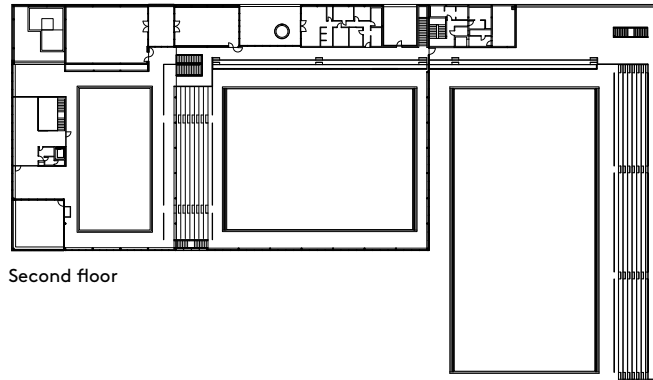

Second floor

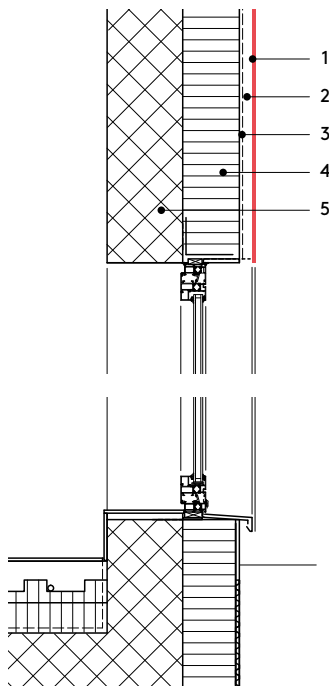

Vertical section 1:20

- 1 Swisspearl® LARGO panel 8 mm
- 2 ventilation cavity
- 3 moisture barrier
- 4 thermal insulation
- 5 concrete

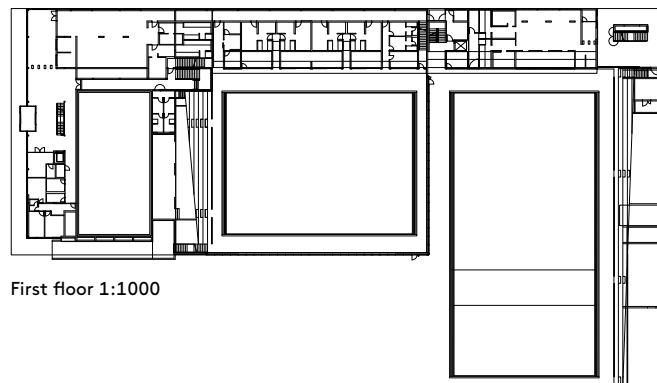

First floor 1:1000

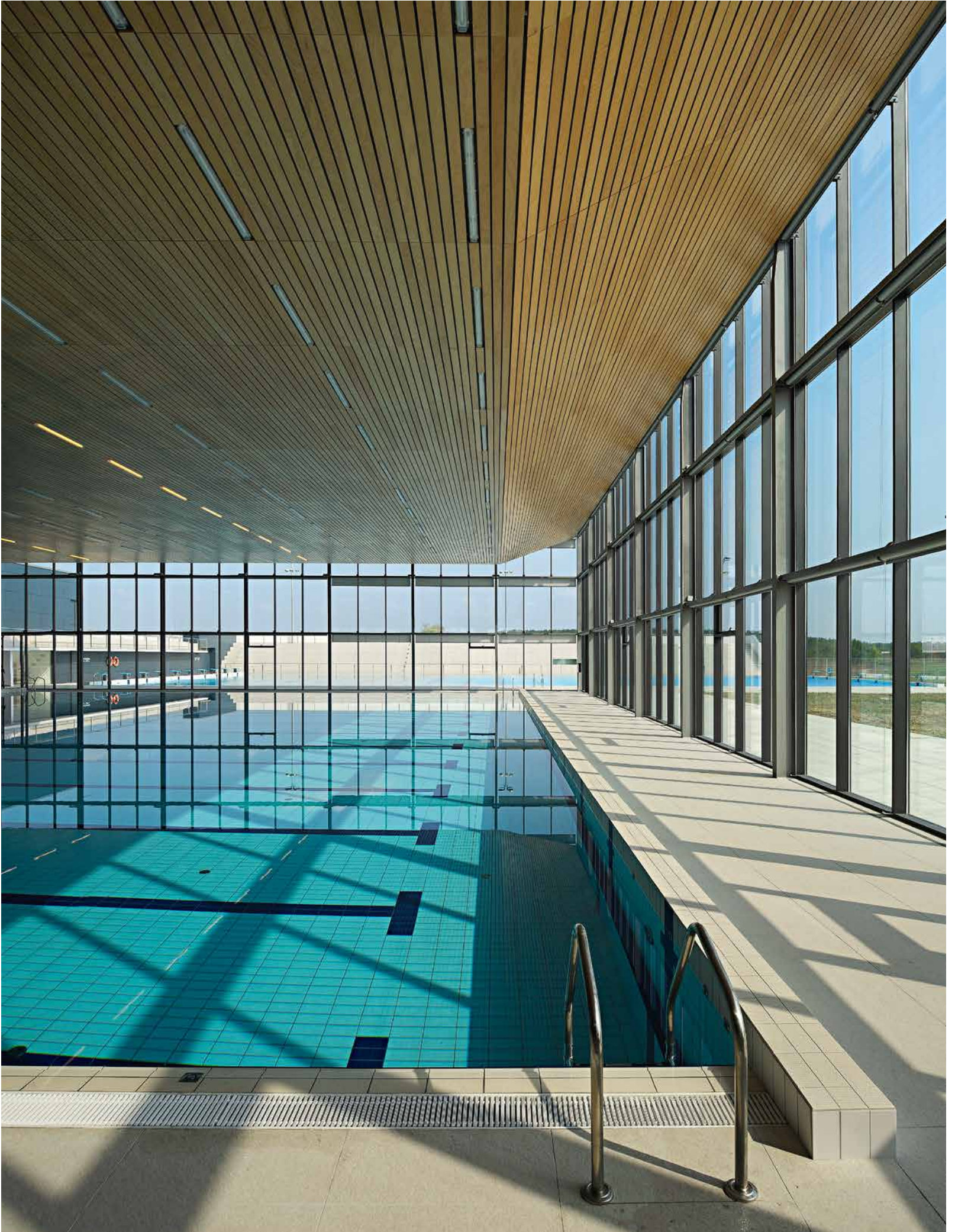

PORTUGAL

REFINED DOCKYARD

Sailing Center, Viana do Castelo

LOCATION: Harbor area CLIENT: Municipality of Viana do Castelo ARCHITECT: Tiago Castro, Viana do Castelo

BUILDING PERIOD: 2013 GENERAL CONTRACTOR: António Alves Ribeiro & Filhos, Esposende

FAÇADE CONSTRUCTION: Statuscontraste, Porto FAÇADE MATERIAL: Swisspearl® LARGO, CARAT Coral 7031

Part of a larger port regeneration scheme, this new facility on a disused pier provides ideal conditions for Viana's renowned sailing club. Divided into two separate volumes, the center offers social amenities as well as a large training and storage hangar. Clad in uniform red Swisspearl panels, the building fits in with the utilitarian structures of the existing shipyard.

PATRICK ZAMARIÀN Over the past decades, Viana do Castelo, once a major seaport in the far north of Portugal, has been suffering steady economic decline, retaining a number of its traditional shipyards, but losing out on the all-important transatlantic trade. Taking advantage of the unique geographical and natural features of the site, the city council has recently embarked on a regeneration strategy aimed at re-branding the port as a “sea center,” essentially a cluster of facilities that cater to various water sports activities. A key element of the plan was the relocation of Viana's long-established sailing club, which runs its own school and organizes internationally renowned regattas, from its confined and dilapidated premises further upstream to a more central site on one of the disused piers reaching out into the estuary.

Two distinct volumes

The new facility comprises two separate volumes linked by a glazed entrance vestibule and arranged in an L-shaped plan around a large, paved courtyard, which allows sailors to maneuver and temporarily store their boats before lowering them into the water via a newly-created ramp. Oriented in a north-south direction, the longer of the two volumes accommodates the actual sports facilities and consists mainly of a steel-framed hangar, which incorporates a suspended walkway along its eastern edge, defining two zones of varying height to provide for the storage of different-size vessels. The northern-most end adjoining the vestibule is allotted to service rooms at ground level as well as the school's second-floor training area overlooking the hall. Set at a right angle, the smaller building contains the club's social

amenities. In addition to changing rooms, the ground floor offers a number of assembly rooms that can be used in connection with sailing events; the upper level holds the administrative office and a small catering kitchen with independent access via an external staircase.

Refined modesty

Fully exposed to the singularly harsh conditions on Portugal's Atlantic coast, the center imposed high requirements on the design of its weather skin. In order to regulate the room climate and minimize future maintenance, architect Tiago Castro opted for a ventilated façade system wrapped in uniform red Swisspearl panels, subtly framed by white drainpipes and roof edges and punctuated by gray-framed window openings. Slatted gates allow constant cross-ventilation within the hangar, whilst the extensively glazed, south- and west-facing social spaces of the smaller volume are sheltered from the sun by a timber-slatted annex structure.

The new sailing center impresses with its modesty. Resisting the temptation to echo the maritime surroundings by mimicking the shapes of sailboats or the azure color of the sea, Castro drew his inspiration from the utilitarian structures of the existing shipyard, relying exclusively on the careful handling of proportion and detail and the quality of the façade material.

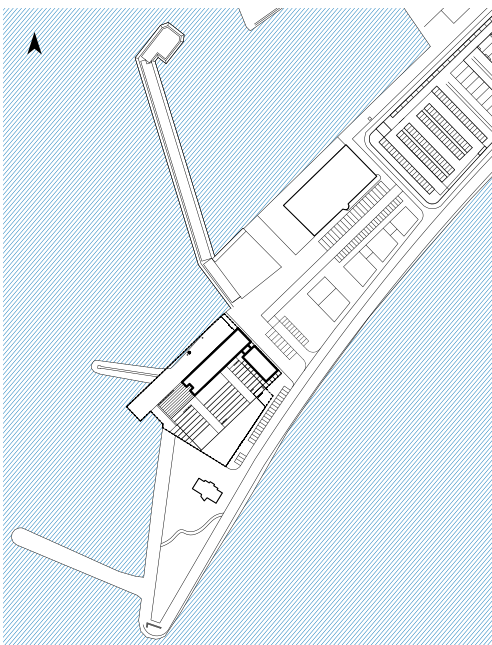



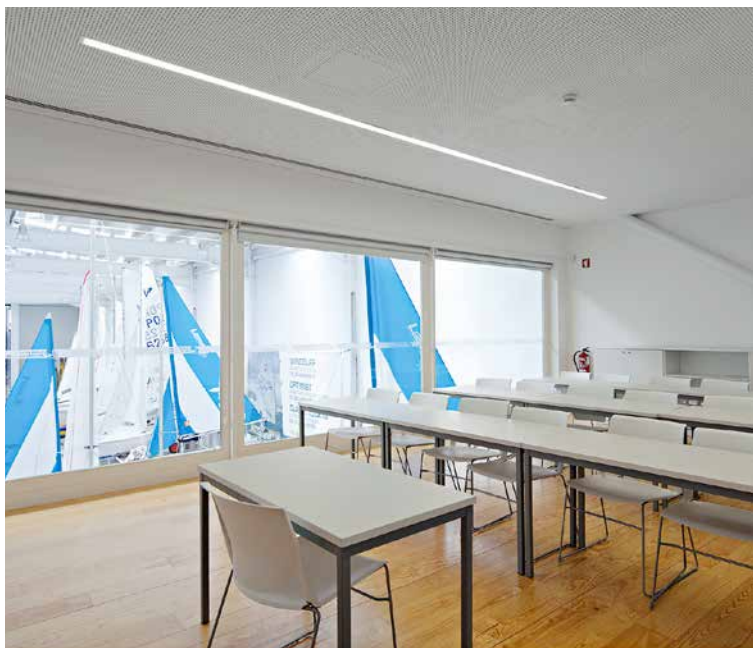

“Since the port area is subjected to an especially aggressive climate, we opted for a ventilated façade system with a full lining of Swisspearl panels, thus substantially reducing the need for further conservation work.”

Tiago Castro, architect



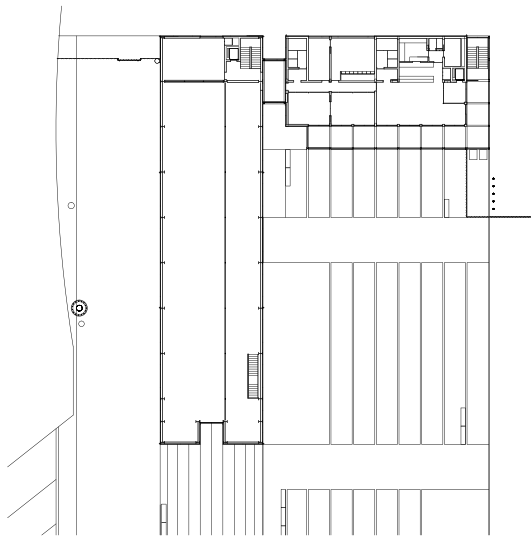

First floor 1:1000

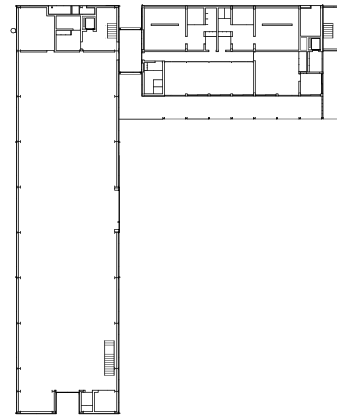

Second floor

The two volumes are arranged in an L-shaped plan. The assembly rooms of the smaller building are sheltered from the sun by a timber-slatted annex structure.

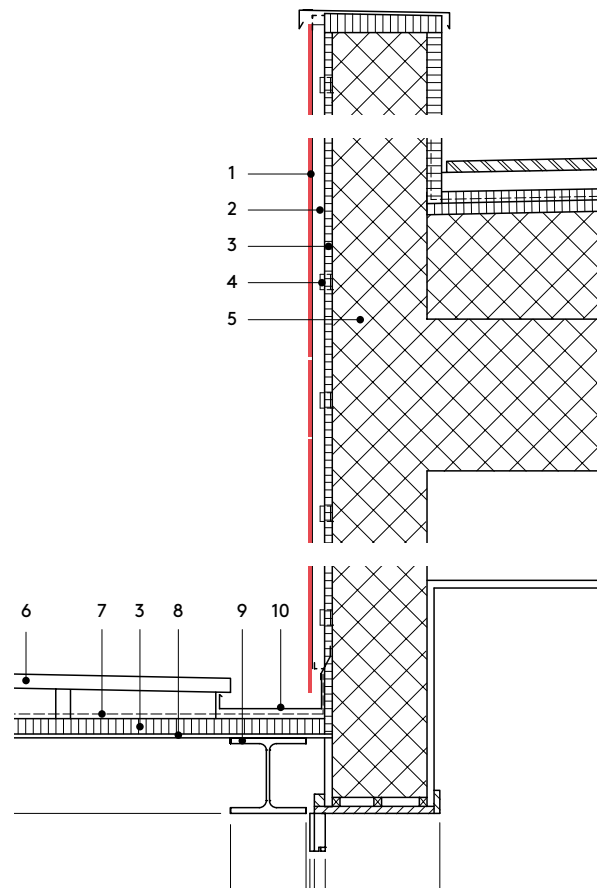

Vertical section 1:20

- 1 Swisspearl® LARGO panel 8 mm
- 2 ventilation cavity, vertical sub framing
- 3 thermal insulation
- 4 bracket
- 5 concrete
- 6 sheet metal roof
- 7 waterproofing
- 8 gypsum plaster board
- 9 steel beam
- 10 water gutter

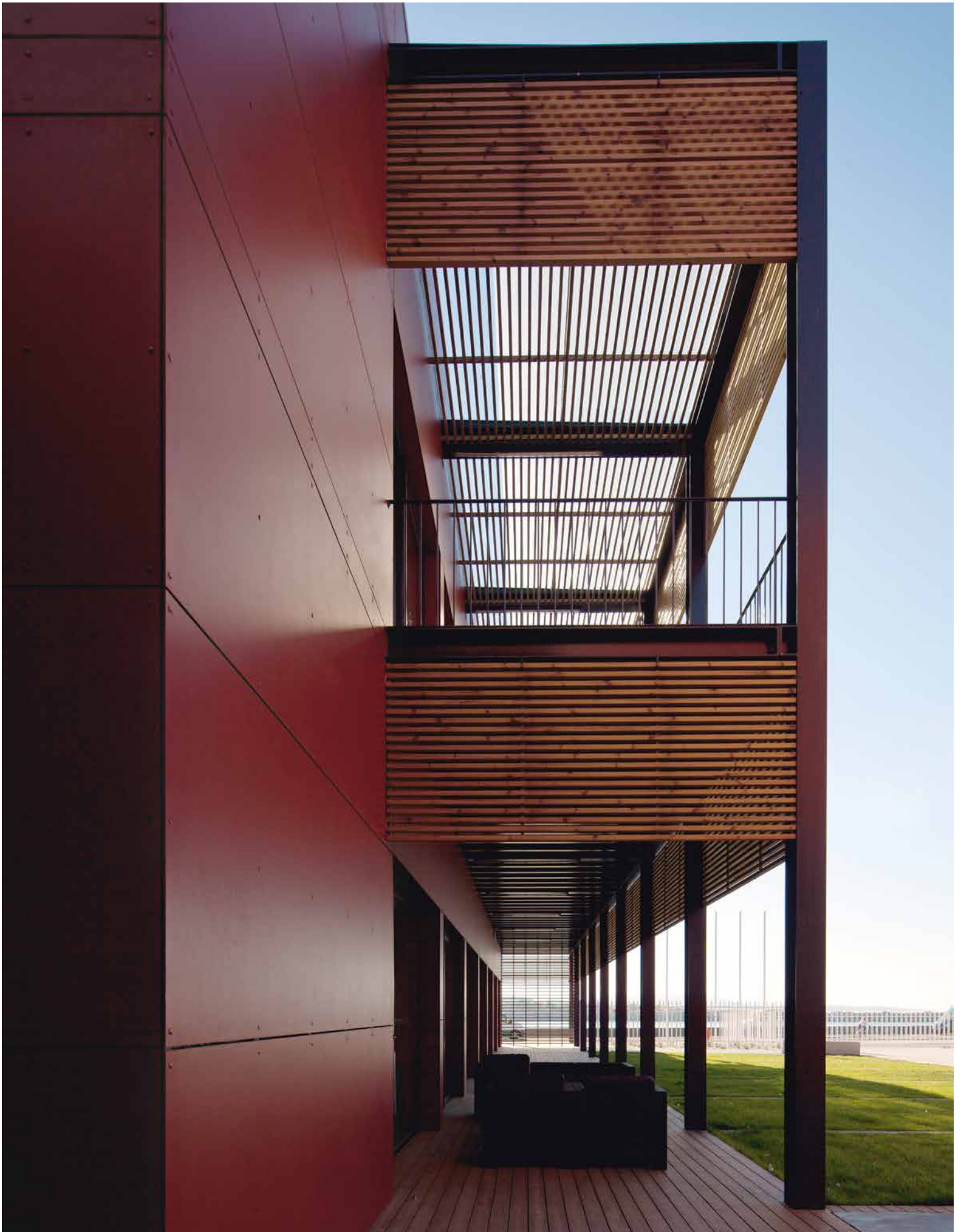



THE WATERFRONT AS VANGUARD FOR A SUSTAINABLE URBAN FUTURE

Essay by Kees Christiaanse

In many port-cities, former docklands play a key role as development locations for attractive, water-oriented neighborhoods. These neighborhoods often appear to form a breeding ground for forms of urbanity that are generated by an unorthodox mix of buildings, uses, and public space. We can even say that in these areas the continuation of a contemporary idea of urbanity can be safeguarded and provided with new meanings. Waterfronts oscillate typologically between two extremes, "City-branding"-waterfronts as

representative symbolic places with a high degree of density, shopping, entertainment, and gastronomy in combination with residential and working facilities; and "waiting lands," which are further from the center, offering the opportunity to develop interesting new forms of coexistence between living environments and industrial production.

Kees Christiaanse is an urban planner, architect, founder, and partner of KCAP, and professor at ETH Zurich.





Bahia de Pasaia San Sebastian (Spain), planning 2009–2011



FredericiaC (Denmark), planning since 2011

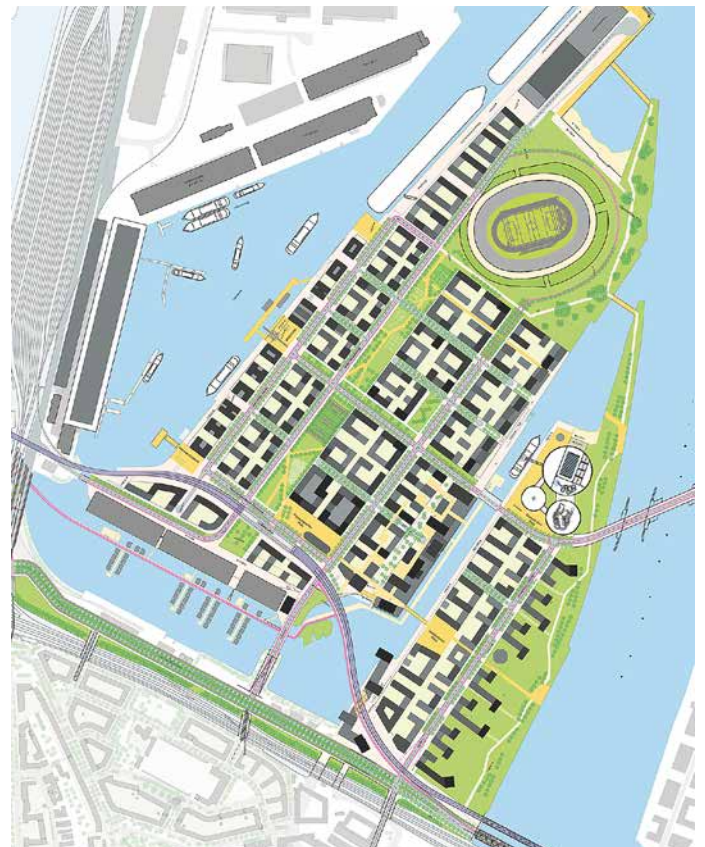

Olympic City Hamburg (Germany), planning since 2015



Baoan Water City Shenzhen (China), planning 2014



Hafencity Hamburg (Germany), planning since 2000



Hafencity Hamburg (Germany), planning since 2000



Oostelijke Handelskade Amsterdam (Netherlands), planning 2000–2009

Looking back at the many waterfront projects we have worked on since the early 1980s, in retrospect, the revitalization of former port-areas in European cities emerged parallel to current fundamental changes in the economy. Here I don't mean the gradual economic changes that caused shipyards and cargo-terminals to move to larger premises closer to the sea, releasing inner city port-areas for development. Instead, I mean rapid atomization and concentration under the influence of economic globalization, which has led to a Renaissance of the city and a demand for qualitative, dense mixed-use urban neighborhoods, where excellent transportation connections and walkability go hand in hand.

This Renaissance of the city is not the result of nostalgic politicians' or compact-city urbanists' ideologies, but rather, an economic change in which the partial atomization and centralization of households, diverging lifestyles, time-schedules, and new relationships between production and consumption call for different spaces, urban typologies, and amenities, in short, a different type of city.

With respect to diversifying age groups, household patterns reflect an increasing demand for safe and attractive urban living in combination with work spaces and a sufficient supply of retail shops and restaurants.

Manufacturing is becoming more automated, clean, and customized, and has begun to return to the city. As technology firms become global giants, they atomize and outsource the production of parts and software to local creative industries, which in turn, attract all kinds of secondary services. E-trading leads to new forms of the distribution of goods and transport modes.

Former port-areas have proven to be exquisitely suited to house this emerging urban culture due to their central location, the attractiveness of water-oriented public spaces, and the adaptive re-usability of industrial buildings. The specific identity resulting from the combination of these characteristics attracts various social groups, stimulating mutual exchange and consequently forging urban communities.

Today, the more than thirty-five years of experience in waterfront development has produced precise and conscious strategies of city-branding, cultural engineering, investment, and programming to sustain this urban

culture. In the early 1980s such a future was not yet foreseeable.

Comparing, for instance, the early East Docklands developments (Oostelijke Havengebieden) in Amsterdam—the planning of which began in the early 1980s—with the HafenCity in Hamburg, developed fifteen years later, a difference in approach becomes apparent. The early Amsterdam Docklands were developed pier by pier and filled almost exclusively with a monoculture of housing, although with very experimental typologies in the grand housing tradition of the Netherlands. The piers, sometimes containing 2,000 or more apartments, were mainly tendered to institutional investors or housing corporations and handed over in lease-hold. The HafenCity in Hamburg, on the contrary, evolved within a robust urban

design structure of streets, quays, and harbor basins in which some functions dominate locally, while a considerable degree of mixed use, active street fronts, and diverse building typologies is always maintained. Instead of pier by pier, the HafenCity was generally developed block by block or cluster by cluster and given in freehold to different commercial and institutional parties, resulting in more incremental growth and vibrant functional and architectural diversity.

A catalyzing influence in the change of this approach over time were the squatters, cultural agents, and creative entrepreneurs who had invaded the gradually abandoned docklands prior to the official revitalization projects, emulating New York's loft culture from the 1950s to the 1960s. Already in the early 1970s, when shipyards were leaving the docks, these groups were inspired to use the characteristic, large and cheap warehouse structures as artist and recording studios, theaters, concert-halls, and alternative living spaces. They also colonized and activated the quays with a "City as Loft."

These initially informal occupations based on political negotiation and policies of tolerance were gradually acknowledged as valuable for the establishment of an urban culture and internalized by municipalities and commercial parties. Buildings such as the Tate Gallery in London or even the Elbphilharmonie in Hamburg, which are converted existing structures, can be seen as exponents of a "domesticated sub-culture" becoming important

**Former port-areas are
exquisitely suited
to house an emerging
urban culture due
to their central location,
attractive water-
oriented public spaces,
and the re-usability
of industrial buildings.**

branding flagships. But more significant for the local urban culture and community-building is the programmed coexistence of creative grassroots activities with new residential and commercial developments. Municipalities are consciously reserving certain areas and older buildings with lower rents for such usage and developers even incorporate these functions in their master plans. In the “Pakhuizen” project along the Oostelijke Havenkade in Amsterdam, the investor, convinced by the architects and the municipality, instead of constructing a gentrified enclave of exclusive apartments and offices, realized a mixed-use program including artist studios, social housing, and a branch of “Fifteen,” Jamie Oliver’s restaurant, where ex-delinquents work as service personnel. Here, at lunchtime, CEOs of international companies are served by staff being symbolically reintegrated into society. This combination of high-culture/low-budget and low-culture/high-budget made the project a key feature, hence sustaining the real estate’s high value.

Waterfront sites that are more remote from the center, and thus less under development pressure may show an inverse program development. In the NDSM shipyard in Amsterdam or Heijplaat in Rotterdam, the sites are primarily activated by the high-culture/low budget side, educational facilities and self-constructed loft-housing, while very centrally located waterfronts, such as the Oostdoks Island in Amsterdam, which was developed at the same time as Hafencity Hamburg, tend to become CBD-like centralities, housing libraries, museums, university-colleges, and trade-centers.

We are currently working on the master plan for the German 2024 Olympic Bid in Hamburg, situated opposite the Hafencity on the other side of the Elbe river, where hard-core harbor activities and industries still dominate. This project, which intends to use the Olympics as an instrument for sustainable urban renewal as was done in Barcelona, Vancouver, and London, is unique in the sense that it tries to integrate industrial activities within an urban neighborhood, providing the very conditions that the economy of atomization and centralization, as described above, demands. Quay-walls and natural embankments, bridge elements, as well as traditional warehouses, railroad tracks, and cobblestone-surfaces are respected, as

enhancing the identity and heritage anchor of the site. Converting such sites into all-encompassing urban districts is a sign counteracting the common monofunctional suburbs and business parks, and thus a promise of an exemplary urban condition.

Since the early projects, waterfronts have proliferated widely, spreading across Europe to Copenhagen, Oslo and Helsinki, Antwerp, Marseille, Barcelona, and San Sebastian. They have greatly influenced the architecture and urban design culture in these cities and informed the revitalization modes of other urban renewal sites.

Since the 1990s and especially since the economic boom in Asia, the waterfront, exported from the European model and from commercial U.S. waterfronts, such as Baltimore and Boston, has become a true symbol of urban

marketization, reflected in projects like Pudong Island in Shanghai, Hongkong Central, or Marina Bay in Singapore. They are part of a new generation of “Grand Projects,” with which cities undertake major gravitational shifts. These projects are generally conceived and planned in a top-down mode, leaving little leeway for a diverse urban culture to emerge.

An alternative “Grand Project” constitutes our proposal for the Baoan waterfront in Shenzhen, a forty-five-kilometer stretch of

former mangrove landscape and wetlands hinterland, which within twenty years has turned into a hard-edged industrial wasteland with a motorway on piles running through the sea and the airport along the shore. Envisaged for this project is a reconciliation between water management and natural regeneration in combination with urban and mobility structures, which can be realized over time incrementally as a therapy of repair for the damage done to our environment by industrial waterfronts of the past.

**Waterfronts have
greatly influenced
the architecture
and urban design culture
in some European
cities and informed
the revitalization
modes of other urban
renewal sites.**

Literature

Martina Baum and Kees Christiaanse, *City as Loft. Adaptive Reuse as a Resource for Sustainable Development*, Zurich 2012.

Kees Christiaanse, “The Grand Project: Creating Urban Centralities in Distinct Contexts,” in *Harvard Design Magazine*, no. 37, 2014, pp. 118–123.



EMBOSSMENT

DIALOGUE OF SURFACES

Religious believers from local communities conceived the idea for this ambitious project in Bern well over a decade ago. As a result of their vision of creating an interreligious space, Europan5 launched an architectural competition in 1999, which was won by Madir Shah of Urbanoffice in Amsterdam. The competition marks the start of a fifteen-year-long process of realization.

ANNA ROOS The core idea for this project was the creation of a place that would accommodate sacred spaces for five world religions under one roof: Christianity, Islam, Hinduism, Baha'i Faith, and Buddhism—a unique place of worship that facilitates the meeting of people from different cultures, nationalities, and religious groups in one place. Fifteen years later, the 25,800-square-meter, mixed-use building has finally opened its doors. Situated on a previously neglected site wedged between a motorway and railway on the west of Bern, the project was conceived as a city gate creating a landmark at the train station on Europaplatz, defining the convergence of the city and its periphery where there is a large population of non-Swiss origins. Representatives from these communities joined forces to kick-start the fifteen-year process of building the House of Religions. Through their sheer tenacity and perseverance they have managed to realize their ambitious vision: five religions, one building. This in itself is a remarkable feat. Although only one single edifice, the building accommodates not only religious spaces, it also houses a myriad of other functions: living spaces, working spaces, commercial spaces, and restaurants. The House of Religions, though, is conceived as the heart of the scheme. The architects have denoted a separate identity for it by sliding the double-height glazed façade forward from the main multi-story body of the building. Dark gray Swisspearl panels with two different embossed surface textures were used as the primary cladding material; this was

well chosen as it is neutral and restrained, allowing the reflective, glazed section housing the religious spaces to be more prominent. Furthermore, as the cement composite panels allow a great deal of flexibility, it gave the architects the freedom to configure the fenestration in different ways and to denote the various stacked functions. Thus, the higher “head” of the building has a raster of long horizontal openings, whilst the main body has a mix of square and vertical openings, each clearly framed in light-colored metal. The varying articulation of the façades denotes the various interior functions of the building volumes.

Each of the five sacred spaces has its own interior design that reflects the religious ritual of its faith. The dazzling palette of the Hindu temple with all its gods contrasts the calm white interiors of the Christian chapel by architect Patrick Thurston, whilst an enormous crystal chandelier adorns the double volume of the Islamic mosque. All these spaces feed into the central communal area where dialogue and exchange between the groups are envisaged and where there is also an info center, bookshop, souvenir shop, administrative offices, and service spaces.

Urban Office worked for well over a decade in collaboration with Bauart Architekten and their clients to realize the project, overcoming a myriad of obstacles en route. The House of Religions is concrete evidence that religious communities of different faiths are able to work together peacefully to achieve a common goal. Let it be a beacon of hope to us all!

House of Religions,
Bern, Switzerland

LOCATION
Europaplatz

CLIENT
Association of the House
of Religions

ARCHITECTS
Bauart Architects and
Planners Ltd., Bern, and
Urbanoffice, Amsterdam

BUILDING PERIOD
2012–2014

GENERAL CONTRACTOR
Halter AG, Bern

FAÇADE CONSTRUCTION
Ediltecnica AG, Urtenen-
Schönbühl

FAÇADE MATERIAL
Swisspearl® LARGO,
NOBILIS Black N 012
(textile embossed)

“The starting point for the planning was the irregular arrangement of the façade panels. On this basis, the window openings and frames were developed. Thus, the planning took place from outside to inside.”

Stefan Kesselring, Ediltecnica

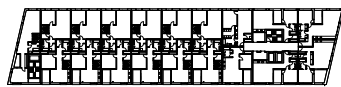
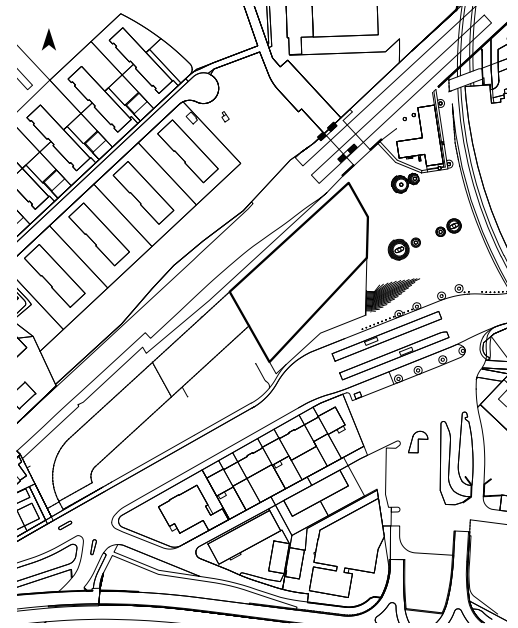

Seventh floor

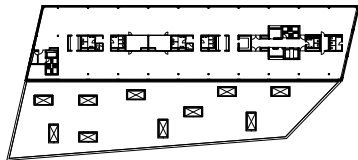

Fourth floor

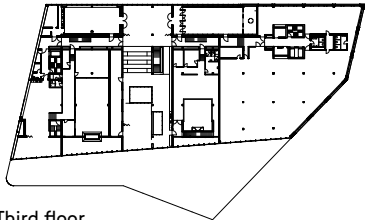

Third floor

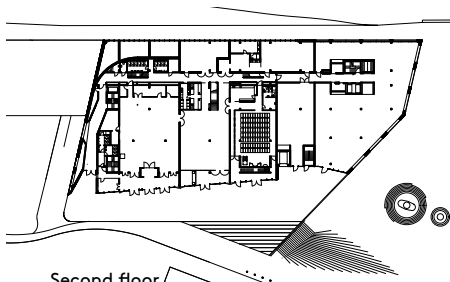

Second floor

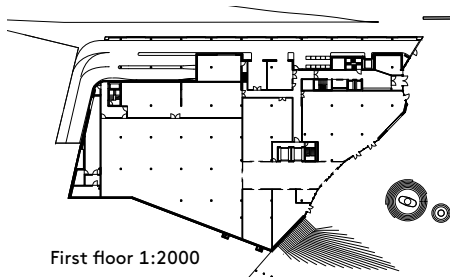

First floor 1:2000

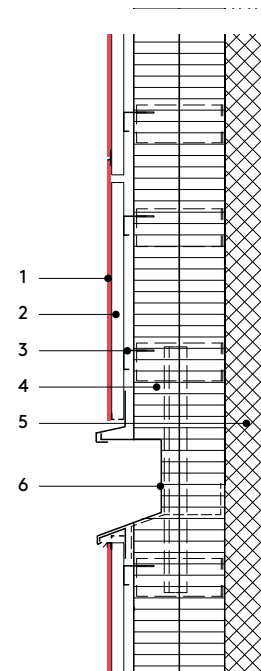

Vertical section 1:20

- 1 Swisspearl® LARGO plate 8 mm
- 2 ventilation cavity, vertical aluminum sub framing
- 3 angle section, aluminum
- 4 thermal insulation, mineral wool
- 5 prefabricated concrete
- 6 horizontal aluminum sub framing



The entry to the House of Religions is demarcated by delicately etched glazing. Seven levels of apartments are stacked above the commercial levels and the House of Religion.

Special Swisspearl panels were prepared for this object. The impregnation of a natural, roughly woven textile structure in the mineral material lends the panels a unique authenticity and depth effect.

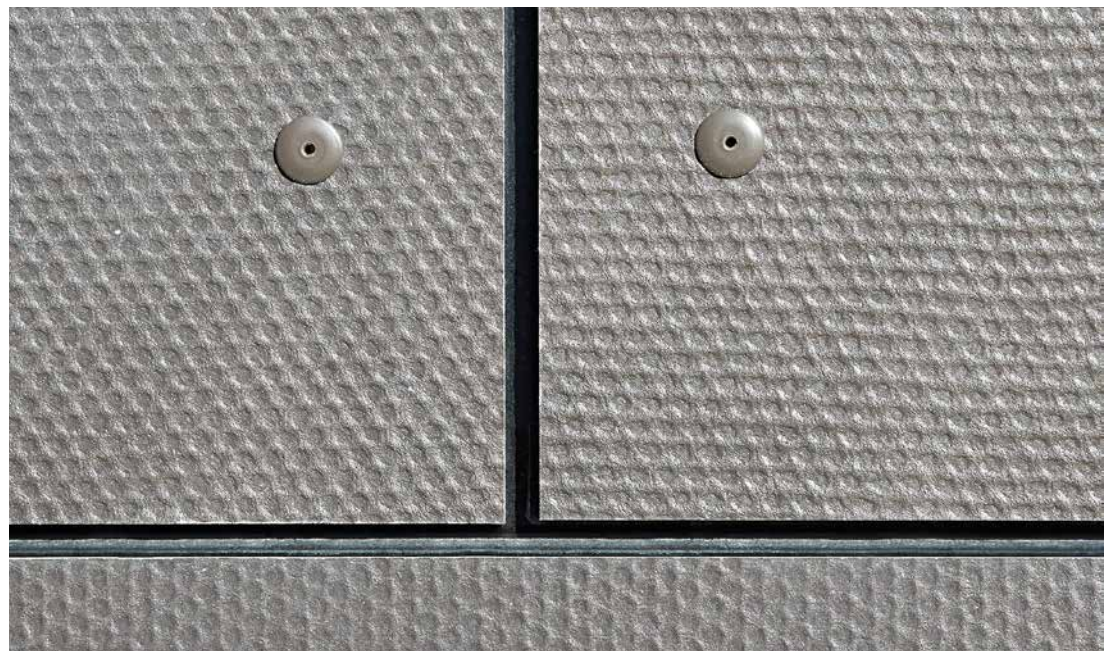



ENGRAVING

120 PANELS FOR AN EAGLE

This vast campus was designed in an astonishingly short time to remedy the acute shortage of high school space in a tornado-hit community in Missouri. Swisspearl provided a solution for part of the exterior cladding as well as a signature wall inside the gym, which features the school's emblem engraved in a two-layered paneling.

PATRICK ZAMARIÀN The tornado that devastated Joplin, Missouri, on May 22, 2011 claimed 161 lives and destroyed almost 7,000 homes as well as ten of the district's twenty schools, including its only public high school. Given the urgency of the situation, DLR Group, working in partnership with CGA Architects, was given merely eight months to plan and design an ambitious new high school and tech campus. True to schedule, the 110-million-dollar project broke ground on the first anniversary of the disaster with work beginning on-site whilst drawings were still being finalized, and in September 2014 Vice President Joe Biden came to Joplin to inaugurate the 45,000-square-meter, 3,000-student-capacity campus in time for the start of the academic year.

The state-of-the-art facility accommodates a pioneering new curriculum, which offers students the choice between one of five career pathways. Instead of clustering similar functions in one place, the architects organized them into four parallel bars separated by themed courtyards and outdoor teaching spaces. The students' four-year progression through the school takes them from one of the small learning communities of decentralized core curricula housed on the cantilevering top level of each bar via academies of focused studies on the middle floor to the large fabrication labs at ground level.

Access to the building is from the east via the commons, a double-story circulation and gathering space, which connects via glazed walkways to the classroom units as well as the top-loaded 2,500-seat arena, the largest of three gymnasiums housed in

a separate building at the heart of the campus. At the two ends of the classroom wing, the program is complemented by a performing arts center and the Franklin Technology Center, which is also open to members of the local community.

The architects combined a variety of low-maintenance materials, such as black box-ribbed metal panels, silver metal panels, and CMU blocks to give texture, depth, and patterning to the building envelope. Large sections of the building are clad in Swisspearl panels in two different shades of red, which break the scale of the large forms whilst adding an element of playfulness to the façades.

Swisspearl panels are also used for the 340-square-meter signature wall inside the arena, which displays the school's emblem, a white abstracted eagle on cardinal red ground, lit by a series of north-facing lanterns. The architects wanted the image to be engraved into the panels, and the company met this unusual request by coating a Carat Crystal base panel with an additional layer of custom-made color. Swisspearl engineers collaborated with outside experts to process the necessary lamination of the 120 units to the required standard before engraving 100 of them and cutting them to the right size. Although this interesting new method is so far limited to interior applications, Swisspearl is at present conducting tests to make it available for façade coverings, too.

Joplin High School / Franklin Technology Center, Joplin (MO), USA

LOCATION
2104 Indiana Avenue (JHS) and
2200 Indiana Avenue (FTC)

CLIENT
Joplin School District

ARCHITECTS
DLR Group, Overland Park (KS),
and CGA Architects, Joplin (MO)

BUILDING PERIOD
2013–2015

GENERAL CONTRACTOR
Universal Construction,
Lenexa (KS)

FAÇADE CONSTRUCTION
PCG, Grandview (MO)

FAÇADE MATERIAL:
Swisspearl® LARGO,
CARAT Coral 7031, 7032,
7031 HR, 7032 HR and PLANEA
Custom color NR152-14-AS1
on Crystal base

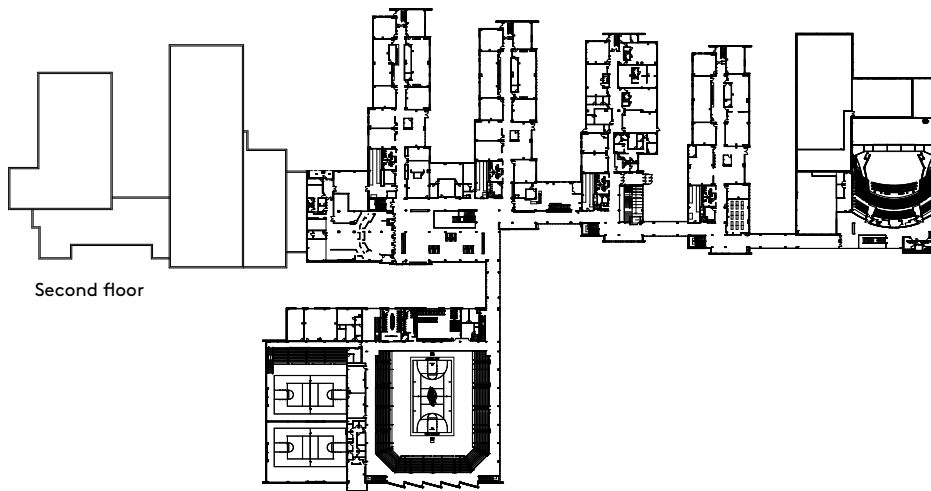

Second floor

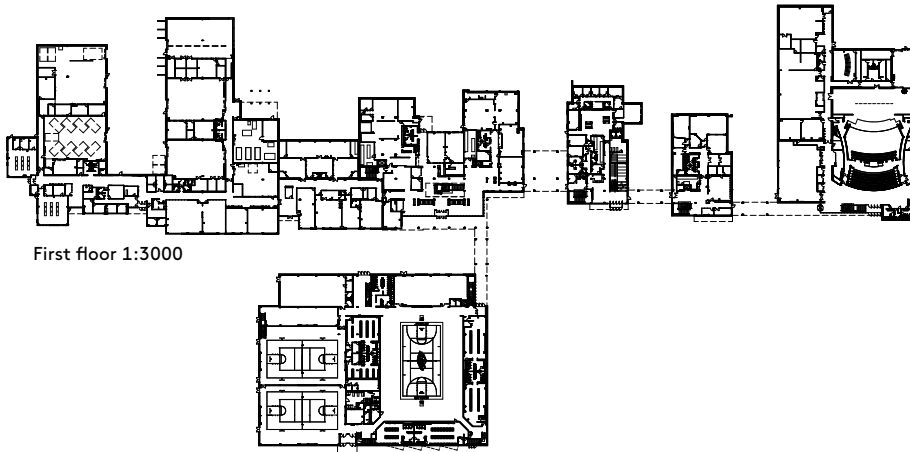

First floor 1:3000

The signature wall inside the arena consists of 120 red-coated white panels. One hundred of these panels were individually engraved to create the image of an abstracted eagle as the school's emblem.

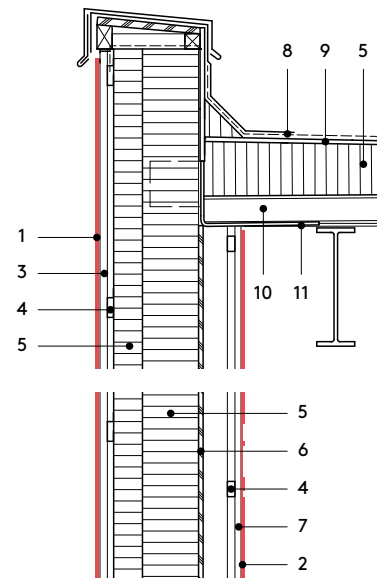

Vertical section 1:20

- 1 Swisspearl® LARGO panel 8 mm
- 2 Swisspearl® LARGO panel 8 mm, engraved
- 3 ventilation cavity, vertical sub framing
- 4 horizontal sub framing
- 5 thermal insulation
- 6 plywood board
- 7 vertical sub framing
- 8 waterproofing
- 9 building board
- 10 corrugated metal decking
- 11 structural steel



Publisher

**SWISS
pearl®**

CH-8867 Niederurnen
Switzerland
phone +41 (0)55 617 11 60
info@swisspearl.com
www.swisspearl.com

The internationally distributed magazine *Swisspearl Architecture* sets Swisspearl cement composite products within a contemporary architectural context.

Advisory board

Michèle Rüegg Hormes,
division manager communication,
Dept. of Architecture, ETH Zurich
Martin Tschanz, docent ZHAW

Editorial committee

Michael Hanak
Janine Löpfe
Marco Pappi
Jürg Schönenberger
Daniel Steinmann
Robert Wirichs

Editor

Michael Hanak, Zurich

Editing

Marion Elmer, Zurich

Translation

Lisa Rosenblatt, Vienna

Design

Bernet & Schönenberger, Zurich

Detail plans

Deck 4 GmbH, Zurich

Printing company

Galledia AG, Flawil

Print run

20,000

Typeface

Brown Pro, Mercury Text

English edition

ISSN 1661-3260

Authors

Mirko Beetschen is a freelance journalist based in Zurich and the Bernese Oberland. As a partner in the Bergdorf AG he edits books on themes related to residential living and architecture. He published his first novel *Schattenbruder* in September 2014.

Kees Christiaanse, born in Amsterdam in 1953, studied architecture and urban planning at the TU Delft. In addition to his activities as architect, he concentrates on tasks in complex, urban planning situations and on the management of urban processes. From 1996 to 2003 he was a professor at the TU Berlin, since 2003 at the ETH Zurich.

Sabine von Fischer is an architect and author and lives in Zurich. She finished her PhD at the ETH Zurich, publishes in the area of architecture and teaches at various universities.

Michael Hanak is a Zurich-based historian specialized in art and architecture. He has a preference for contemporary architectural history and the current handling of it.

Rahel Hartmann Schweizer is a historian specializing in art and architecture. After having worked as an editor and on a dissertation on Otto Kolb, she now writes about the interdisciplinarity of architecture, art, and engineering.

Anna Roos is a Bern-based architect. She writes about current architectural events and works as a translator and editor. She is currently working on her first book for DAAB Publishers.

Patrick Zamariàn is a freelance writer and translator. For his PhD thesis at the University of Liverpool, his focus is on British postwar architecture.

Photos

C1: James Dow, Edmonton
C2: Camille Zakharia, Manama
C3: Rouven Hauri, Niederurnen
C4: Rune Backs, Copenhagen

p. 2: Kurt Hutton (Picture Post/Hulton Archive/Getty Images)
p. 3: Pino Brioschi, Bellinzona
p. 4 top: Baugeschichtliches Archiv, City of Zurich
p. 4 bottom: Archiv für Baukunst, Innsbruck
p. 5 top: Kantonale Denkmalpflege des Kantons Zürich, Dübendorf
p. 5 bottom, pp. 24-27, pp. 56-59: Jürg Zimmermann, Zurich
pp. 7-11: Bent Raanes Sørensen, Tromsø
pp. 12-19: James Dow, Edmonton
pp. 20-23: Jacob Hogan/Ambition Photography, Geelong
pp. 28-33: Ralph Bensberg, Kerns
p. 33 oben: Roger Frei, Zurich
pp. 34, 37: Rizah Konjic, Fornebu
p. 36: LEADinc., Husnes
pp. 38-43: Sandro Lendler, Zagreb
pp. 44-49: José Campos, Porto
p. 51, p. 52 top and bottom left, p. 53 top left: KCAP, Rotterdam/Zurich/Shanghai
p. 52 bottom right: KCAP, Arup, Vogt, Kunst + Herbert, GMP, WES, Drees & Sommer
p. 53 top right: Elbe & Flut/Hafen-City Hamburg GmbH
p. 53 bottom: Paulien Borst
pp. 60-63: Alistair Tutton, Kansas City

Legal notes

Texts, images, photos and graphic work in this publication are protected by copyright and other intellectual property rights. Rights to the texts are owned by the writers in all cases. The contents of this publication may not be copied, distributed, altered or made available to third parties for commercial purposes. Further, some pages include images the copyrights of which are owned by third parties.

This publication has been assembled with the greatest possible care. Nevertheless, the publisher cannot guarantee freedom from error and the complete accuracy of the information it contains. The plans have been kindly provided by the architects. The detailed plans have been reworked for greater legibility; the editors are not able to guarantee their accuracy.

Except for CARAT Onyx and Amber, all cement composite panels Swisspearl® LARGO are manufactured exclusively in Switzerland.

KNOW-HOW

Water is the elixir that first makes life possible. Not only is it necessary for people, animals, and plants, but also for the production of cement composite products: at the beginning of the process, the mixture used to manufacture panels contains, namely, 72 percent blue gold.

A nearly closed water cycle makes it possible for the water used in production to come directly from the wastewater treatment plant: we are recyclers. Only the water that is physically and chemically incorporated into the panels is supplemented with the help of two ground water stations in Rautibach. Every production hour around 350 cubic meters of water, which corresponds with roughly 1,750 bathtubs, pass through the process cycle. When the mixture is pumped on the panel machine and pressed to a first panel, the water content is only circa 18 percent. After a three-week setting time, the cement composite panels achieve a residual water content of 8 to 9 percent. The water is not lost, but instead, chemically integrated into the panel. The finished, coated Swisspearl product ultimately has a water content of circa 5 percent, and corresponds with the equilibrium moisture in the European climate. This is necessary to avoid shrinkage on the façade. A façade panel is constantly exposed to water in the form of rain, snow, or humidity. Depending on the weather, it absorbs or releases an insignificant amount of moisture—a component that harmonizes flawlessly with its surroundings.

Water accompanies us every day in the production process. It flows from the Glarner Alps as a stream through our production plant in Niederurnen and from the “Rautibrunnen” into production. Afterwards, the filtering plant purifies the water in several stages before it is re-introduced into production. The minimal excess water is fed back into the course of the stream, for which there are strict legal stipulations. Ducks swim on the stream; it brings a sense of calm and leisureliness into the loud production plant. And when we enjoy a break at noon in the staff restaurant, directly on the stream, it is clear: water is Swisspearl’s elixir.

Specific values

- 72 percent water is required in the manufacturing process of cement composite.
- 350 m³ water per hour are constantly in the process cycle.
- ca. 5 percent water content remains in the building material cement composite.



Marco Ziethen, Head of primary production Swisspearl



The "Rauti" stream runs right through the company grounds in Niederurnen.



Houseboat "Solo" in Nykøbing, Denmark, 2006/07, Waterliving A/S, Copenhagen.

AT THE WATERFRONT

This edition of *Swisspearl Architecture* shows on the basis on several examples how building on water with cement composite takes place. The architectural historian Rahel Hartmann Schweizer provides an account of how building on water has changed over the course of history. And the architect and urban planner Kees Christiaanse talks about the transformation and development of harbor cities against the backdrop of his own designs.