



SWISSPEARL ARCHITECTURE 20

International Edition – High Profile Buildings

swiss
pearl®

SWISSPEARL ARCHITECTURE 20

Report

2 **Home is Where the Heart is – Designing Houses to Live in**

4 **Residential Apartment Blocks, Brescia, Italy**
Studio 5+1AA, Milan

10 **Common Public Housing, Copenhagen, Denmark**
ONV Architects, Vanløse

16 **Pisissia Residence, Nuuk, Greenland**
AB Tegnestuen Aps, Horsens

22 **Casa Montarina, Lugano, Switzerland**
Lorenzo Felder, Lugano

28 **Semi-detached Houses, Uboldo, Italy**
Marco Castelletti, Erba

32 **House GV-17, Sveti Martin na Muri, Croatia**
Vedran Pedišić, Zagreb

Interview

38 **Talking with Vedran Pedišić, Zagreb, Croatia**

40 **Sonya Perica Residence, Sydney, Australia**
Jessica Matson, Marrickville

44 **House M2, Bozen, Italy**
Monovolume architecture + design, Bozen

48 **House Hindås, Gothenburg, Sweden**
Inobi AB, Gothenburg

50 **Single-family House, Parede near Lisbon, Portugal**
Humberto Conde, Lisbon

56 **ÉMI Construction Knowledge Center, Szentendre, Hungary**
Puhl and Dajka Architects Ltd, Szentendre

62 **Multi-purpose Centre, Žabčice, Czech Republic**
Jan Mertlík, Prag

Flash Info

64 **Housing Habakuk, Maribor, Slovenia**
Styria arhitektura d.o.o., Maribor

PRIVATE LIVING



As everyday life becomes more and more determined by increasing workloads and accelerating time pressure, the idea of privacy is undoubtedly gaining importance. Quite certainly it will be one of our major challenges to differentiate between private and working life. Will we still be able to draw a clear line between both lives in the future? Will it be possible to leave our

workload in the office or will we be forced more than ever to take work home with us?

The answers to these questions might turn out rather individually. But no matter what they are, privacy will become more precious than ever before and private living will need to be seen on another scale. No wonder that private living appears to be an increasingly individual matter with more effort put into than ever before. No matter if home is the place to relax from work or to continue working, the significance of this ambiance is pivotal. Never before has private living been as multifaceted and distinct as today.

The Swisspearl projects being featured on the following pages perfectly reflect this trend. As you will see, there are no limits to creativity and individual taste. Enjoy reading and indulge in the world of private living.

**Robert Wirichs,
Head of Business Unit Export**

Designing Houses to Live In

HOME IS WHERE THE HEART IS

The last issue of SWISSPEARL ARCHITECTURE focused on communal living in all its guises: universities, housing estates, schools and nursing homes. In this current issue, the focus is turned towards the 'the home' that is so central to our everyday lives and to our general sense of wellbeing, both psychologically and physically. Examples of the various forms of living are shown: from low-cost, high-density apartment blocks to single-family luxury villas. The broader and very topical issue of housing in disaster zones such as the current calamitous situation in the Philippines, in refugee camps in war zones, or in shanty towns, although obviously critical, does not lie within the scope of this essay, but needs a highlighted mention nevertheless.

When musing about this enormously broad topic – a topic that lies at the heart of every one of our lives regardless of our status, age or nationality – a myriad of questions need to be posed. For whom are houses built? Are they built for the inhabitants, the investor, or the public who see them? How does a house become a home and how does the house interact with its inhabitants? Furthermore, how does it interact with its environment, its urban, suburban or rural context? Is it

ecological? And long term: How can a home enhance all phases of life as the years progress and our needs evolve?

Architects and planners have to carefully consider all these diverse aspects, they have to speculate and imagine what scenarios might look like in the future. They have to imagine unique individuals, of all ages and all backgrounds who might live in these spaces, without reducing the client to an abstract, faceless 'user'. There is the push-me-pull-you user versus the architect. To what extent does one invite the user into the design process? The late Steve Jobs famously said, "It is not the function of the user to know what he wants." In other words, it is the role of the designer to pre-empt the users' needs and awaken their desires. But many would disagree with this assertion, strongly believing in the necessity of close dialogue with future residents in the process of planning and developing housing.

In approaching any design, one has to identify the target group or groups, being mindful of the changing demographic trends in our cities. In Switzerland, for instance, there seems to be an increasing drift towards one-person households, many career women choose not to procreate and many people simply don't ever

**Housing estate
Harossen at Brütten,
Switzerland
(2009–2012), by
BDE Architects.**





**Oberfeld Residence
in Los Angeles
(2007–2010) by
SPF:architects.**

meet Mr or Mrs ‘Right’, or simply prefer to live on their own. Furthermore, there is also an increase in single-parent families and patchwork families, whilst some couples are choosing to have larger families with four or five children. Some singles join forces and form digs, sharing costs and avoiding the isolation of living alone. The fact that our homes often double up as our places of work also needs to be kept in mind when designing houses. This growing trend, known in Japan as SOHO, small office, home office, is where self-employed workers use their dining room tables and laptops as offices. Our aging population in the West means that building for the elderly has also become central to the issue of housing. According to sociologists, integrating the elderly into mixed-use developments seems to have a positive influence on both old and young.

For the sake of our environment – and to try and reduce the encroachment of urban sprawl – the tendency of urban planners has been to increase urban density with multi-storey apartment blocks. This prevents a rash of single-storey, single-family homes from consuming the green belts around our cities, merging neighbouring cities into mega-cities where many millions of people live and work. Redeveloping brownfield sites and the renovation of old industrial buildings or churches into modern housing has been the norm for some time already. The enormous, abstract, hard-edged new-builds in cities like Zurich and Geneva are also giving way in some instances to a more humane pattern language for new housing à la Christopher Alexander. For example, medium-density row houses are being reinterpreted, creating places where scale and form does not alienate, places that are homely and welcoming. The new housing estate Harossen in Brütten, near Zurich, is an example of this, where 1920s row houses have been reinterpreted for comfortable human-scaled family living. Thankfully, the tight, minimal dimensions of the post-war ‘Neufert generation’ of apartment planning that advocated, for example, three-room apartments of only 75 m² and ceiling heights of a mere 2.5 m, have

given way to an acknowledgement that using minimal dimensions has a detrimental effect on the quality of living. People generally don’t like living under low ceilings or in tight spaces.

The central criteria in the design of a house can be summarised. Firstly, the position of the house, whether it is close to amenities and to public transport and what kind of environment surrounds it. Is there a green space nearby, a garden, or a park where children can play? How much capital is available and what is the budget, are also central issues. Secondly, the functionality of the design has to be considered, whether it fulfils the spatial requirements of the user or client. Thirdly, the more subliminal, but vital, qualities come into play, like materiality, the view, orientation and daylight, what the atmosphere is like and how it feels to be in the house. The final point is imperative to the overall quality of a house and is central to the atmosphere created: The way a building is articulated, the colours and textures that have been employed, have an enormous effect on how people perceive a building. The housing development City Life in Brescia, featured in this issue, is a pertinent example of how surfaces and textures can make a housing development playful and can reduce the scale, creating an aesthetically pleasing environment.

Houses are not mere stage-sets built to supply glossy lifestyle magazines with pretty images, rather they have a physical presence and longevity that lasts many decades, if not centuries, long after the architect and builders that built them have been forgotten. We should be trying to create lively communities and affordable houses; we should be aiming to make houses where we, ourselves, might all truly wish to live. *Anna Roos*



Three apartment blocks create a collage of colour and texture around a green park.

Residential Apartment Blocks, Brescia, Italy

BLUE COLLAGE, VILLAGE GREEN





Vertical sections built up by the façade treatment, alternating Swisspearl panels, shingles, tiles and timber cladding, create a visual collage.



City Life, a housing scheme designed by the architects Studio 5+1AA is situated in a former industrial area to the southwest of Brescia, 80 kilometres east of Milan. Brescia is the centre of the third largest industrial area in Italy, producing mainly mechanical tools. Brescia is also historically significant for its role in the art of violin-making.

The residential scheme has three blocks, each four storeys high. Two are configured in an L-shape that opens at the corner junction, forming an entrance from the street and defining its central public park. The third block, somewhat smaller, faces the larger blocks from the far side of the park. The multi-storey blocks accommodate a variety of apartment sizes ranging from 62 m² to 170 m² (two-room to five-room apartments), thus catering for a variety of household sizes from singles to families with children. This demographic mix is healthy as it allows a natural assortment of inhabitants and an interesting range of people of all ages.

What strikes one immediately is the flamboyant treatment of the façades. By subdividing the four-storey blocks into distinct vertical sections, each with its own articulation, colour, texture and form, not only is a playful, light-hearted aesthetic crafted, but the scale



Two long blocks hinge open to create an entry into the park behind.

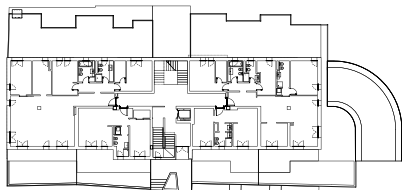

Ground floor 1:1000

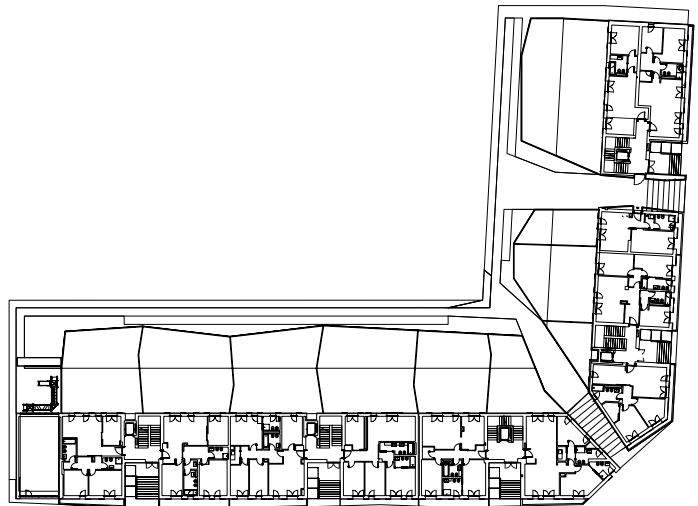

Ground floor 1:1000

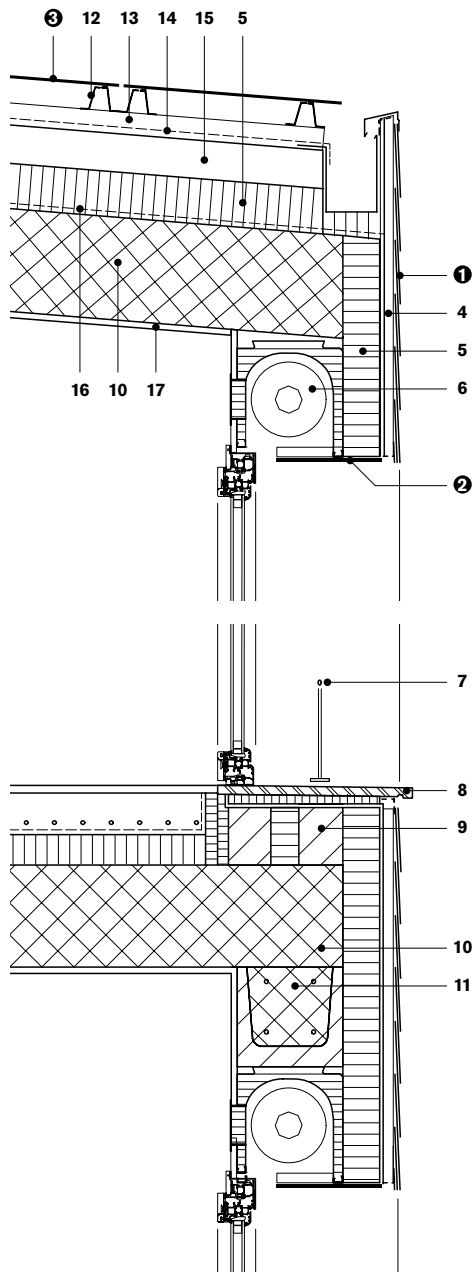

Vertical section 1:20

- 1 Swisspearl® cement composite panel 4 mm, double layer
- 2 Swisspearl® cement composite panel 8 mm
- 3 Swisspearl® cement composite panel 8 mm, R-finish (roofing)
- 4 ventilation cavity, vertical batten
- 5 thermal insulation
- 6 roller shutter
- 7 railing
- 8 marble threshold
- 9 aerated concrete
- 10 concrete
- 11 prefabricated beam
- 12 anodised aluminium supports
- 13 ventilation cavity, aluminium sub-framing
- 14 waterproofing
- 15 cement screed
- 16 vapour barrier
- 17 plaster

of the project is also dramatically reduced. A bold collage effect has been created by the patchwork use of different blue Swisspearl cement composite panels, shingled in places, or with fine vertical timber cladding and undulating shiny ceramic tiles. By varying the roof heights and alternating monopitch and flat roofs, the silhouette of the clipped-eave blocks forms a lively contour line against the sky. The forward and backward shifting of the façades also fragments the long panels, which would otherwise risk being monolithic.

The ensemble of apartments is somehow reminiscent of the pattern language of the coastal town of Liguria, where individual houses are nestled close together, their colourful façades forming colourful kaleidoscopes. The design and complex treatment of the elevations here give the residents a sense of individuality and identity and avoid the risk of anonymity. A strong graphic image is created on a sunny day by the backdrop of blue-sky blending with the two-tone blue façades and the emerald green park in the foreground.

Balconies are used as a strong design element; some extend as cantilevers, whilst others are enclosed in the envelope of the façade. The vertical façades are stepped forward and back to create a rich tapestry of positive and negative, light and shadow, which is further emphasised by the mix and match of colour and texture overlapping and interlinking. The balconies bring a layer of life and movement out of the façade and soften the interface between the building itself and the adjacent park. From their private balconies, the occupants can look down at their own private gardens and beyond to the public park.

Inhabitants of City Life have the positive benefits of having a community of people in close proximity, whilst also having direct access to a large open green space where their children can play and they can socialise. The architecture enhances the suburban surroundings and provides a high-quality living space.

Anna Roos

Location Via Eritrea, Brescia, Italy
Client Draco Spa, Brescia, Italy
Architects Studio 5+1AA, Milan, Italy
Building period 2011–2012
General contractor and façade construction Sandrini Costruzioni, Brescia, Italy
Façade material SWISSPEARL® CARAT, Azurite 7041, 7041R, SWISSPEARL® NOBILIS, N411





Low costs, individual involvement and a community social life are all well-known requests in designing public housing. The AlmenBolig+ programme in Copenhagen is a new concept designed by top-quality architects for mass-produced housing that is nevertheless inexpensive to build and operate.

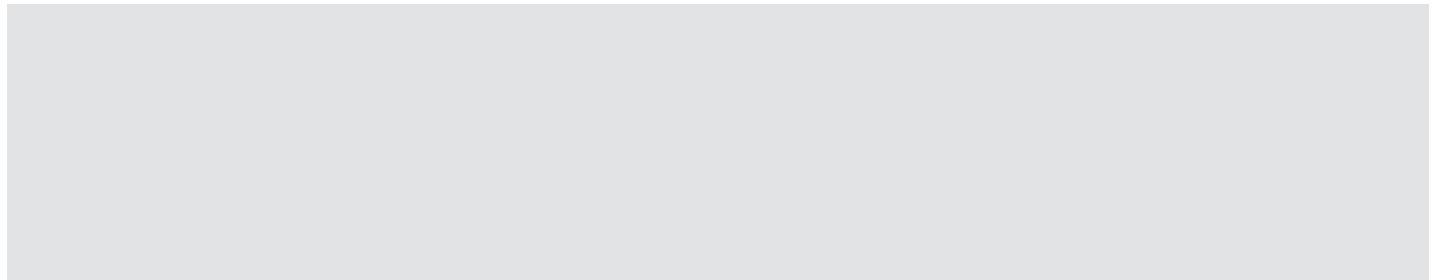

Common Public Housing Emblasgade, Copenhagen, Denmark **HIGH QUALITY FOR LESS MONEY**





The walkways between the houses are car-free and suitable as a common area, safe for children playing and neighbours socialising.

Many apartment buildings are going to go up in Copenhagen this year. With the rapid increase of residents in the city and its surroundings, living space is getting more and more expensive. Searching for new forms of housing, the Copenhagen Common Housing Association (KAB) developed the AlmenBolig+ programme: offering lower rent in exchange for cooperative house maintenance and minor completion work on the interior. Residents are keeping their rent down by jointly managing the upkeep and maintenance of their apartment building. This includes lawn-mowing, hedge trimming, and sweeping and clearing away snow, as well as lubricating window and door fittings and cleaning out gutters. A bonus point: the layout of the apartment can be decided and completed by the tenant.

The design phase should also focus on economy. Since the aim is to achieve high quality at a lower cost, a number of framework tenders were requested. A professional jury chose the best project. The plan was to use the chosen project on several sites in order to benefit from the repetition.

ONV, a successful architecture studio, managed and operated by Søren Rasmussen, was selected to plan and build around 700 AlmenBolig+, not only in Copenha-

gen, but all over Denmark. This local architecture firm has been a frontrunner in Denmark when it comes to prefabricated housing through the use of pre-formed elements that can be varied and adjusted for almost any purpose. ONV has not only developed an aesthetic single-family house prefabricated in wood, but has also found solutions for mass-produced multiple dwellings. “Prefabricated architecture will play a significant role in the construction projects of the future”, says Søren Rasmussen. “If you look at the buildings being built using traditional methods in Denmark today, at least half of these buildings would be better off using the factory-made method.”

In the eastern part of Copenhagen, between Emblasgade and Ragnhildgade, eight row-houses of two or three storeys were recently completed. Houses are assembled using room-sized volume-elements, ready-made at the factory and transported as whole units to the building site, thus achieving optimal construction time and economy. Two-storey houses have their entrances at ground level. Three-storey houses offer handicap-friendly, single-storey apartments on the ground floor with two-storey apartments above, reached via an outdoor staircase to the entrance on the

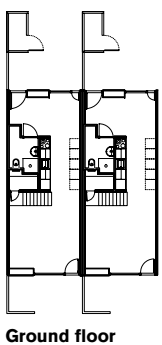
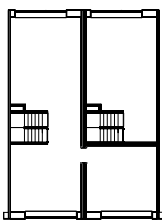
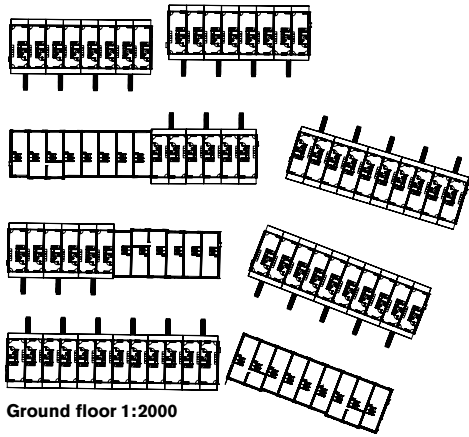
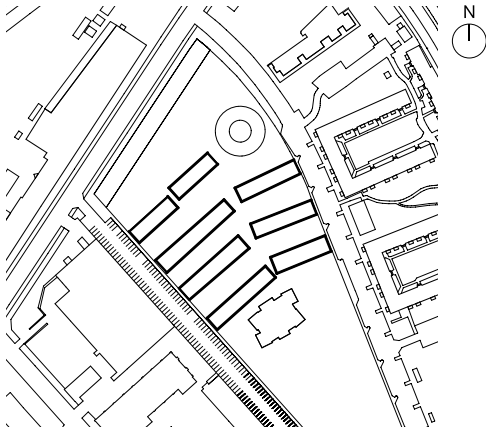

Street-side, the ends of the buildings are connected by garden walls which are also clad with Swisspearl panels and offer protection to the private back gardens.

**“THE RESIDENTS CAN GET A REFUND FOR PART OF THEIR INVESTMENT WHEN MOVING OUT IF THE USE VALUE OF THE APARTMENT HAS INCREASED DUE TO THE CHANGES.”
SØREN RASMUSSEN**



The settlement consists of 113 apartments: large enough to be economically robust, but not too big to have personal relationships with the neighbours.

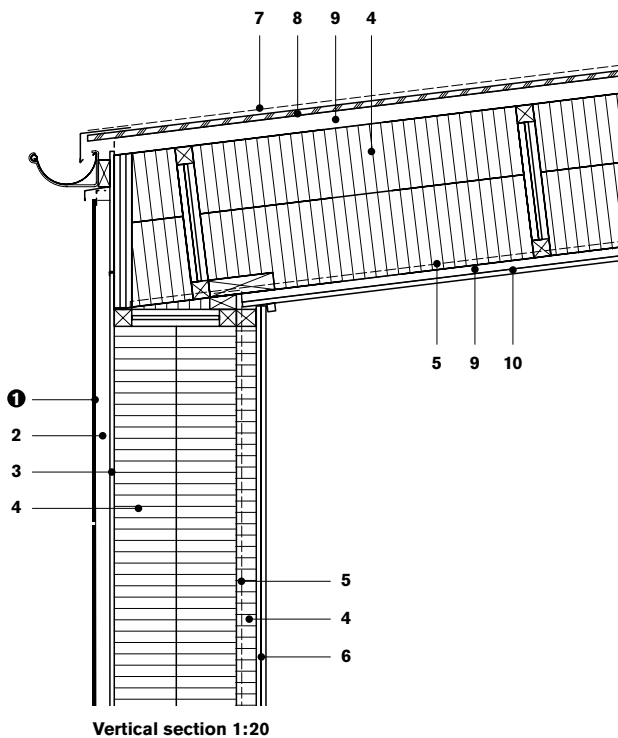

Vertical section 1:20

- 1 Swisspearl® cement composite panel 8 mm
- 2 ventilation cavity, vertical batten
- 3 windstop board
- 4 thermal insulation
- 5 vapour barrier
- 6 gypsum board, double layer
- 7 waterproofing
- 8 plywood
- 9 batten
- 10 gypsum board

first floor. All entrances to the apartments face on the car-free spaces between the houses. Apartments with an entrance on the ground floor have both front and backyards, whilst apartments with the entrance on the first floor have balconies on both sides.

All façades are clad with Swisspearl Carat Black Opal cement composite panels, while the modified bitumen roofs are dark-grey. Outdoor staircases and balconies are made of galvanised steel. Sliding shutters in perforated aluminium, with black or contrasting paint, gives the façade a dynamic expression. Clad with the same material as the façades, the dividing walls between the streets and the private gardens secure privacy and shield against noise.

Each apartment already has a bathroom and a basic kitchen, but the design and layout of the rest is up to the new residents. All utility installations are located in the exterior walls and the walls connecting to the bathrooms, which allows the residents to design their own apartments without having to deal with electrical or plumbing installations. *Michael Hanak*

**“THE BENEFITS ARE A SIGNIFICANT ENVIRONMENTAL GAIN
IN THE FORM OF MINIMAL WASTE OF BUILDING MATERIALS
AND PROVIDING AN OPTIMAL WORKING ENVIRONMENT.”
SØREN RASMUSSEN**



Location Emblasgade 3-167, Copenhagen, Denmark

Client Domea, Taastrup, Denmark

Architects ONV Architects, Vanløse, Denmark

Building period 2011-2013

General contractor and façade construction Scandi Byg A/S, Løgstør, Denmark

Façade material SWISSPEARL® CARAT, Black Opal 7024

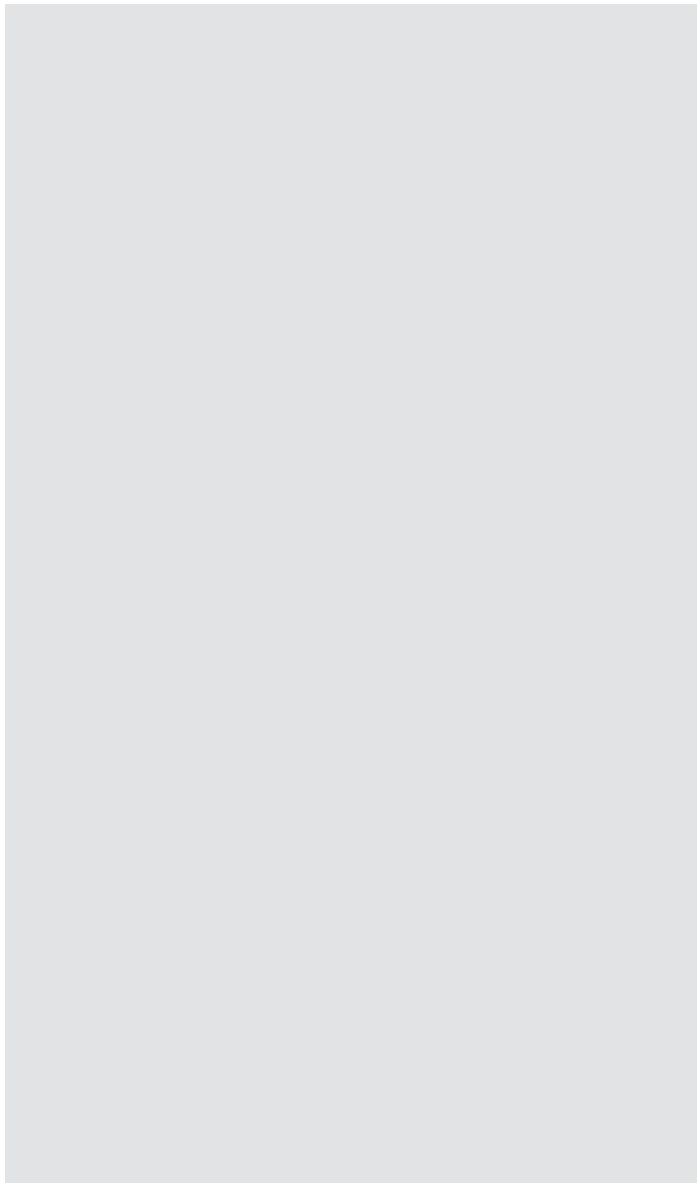

This low-coast housing scheme in the capital of Greenland provides 72 apartments in six separate blocks. In light of the arctic conditions on the island, the developers opted for a prefabricated building system, thus reducing the risk of weather damage and minimising construction time on site.

Pisissia Residence, Nuuk, Greenland

ARCTIC PREFAB





Corner balconies, slanted roof lines and Swisspearl panels in three different colours add visual interest to the scheme.

“THE PHILOSOPHY HAS BEEN TO MAKE BEST POSSIBLE USE OF THE BUILDING PERIOD.” IB BLOCH





“COLOURFUL BUILDING BODIES WITH STRONG SURFACES AND A MINIMUM OF MAINTENANCE ARE PLACED AROUND A CENTRAL SQUARE.” IB BLOCH

Greenland’s extreme climatic conditions inevitably affect the building process and therefore architectural design itself. Icy weather in winter and low average temperatures even during the summer months provide a short time window for any sustained building activity. Even on the comparatively mild and largely ice-free west coast, where the country’s capital and largest city, Nuuk, is located, it is indispensable that building structures are made weather-tight as quickly as possible.

In order to address this problem, general contractor Atcon Greenland assembled a project team in 2004 dedicated to developing an optimised building system for the arctic island. Three years ago this team won an invited competition for low-cost housing in Nuuk tendered by the municipality of Sermersoog. Set in a development area called Pisissia in the growing Qinngor-

put suburb, the scheme was driven by the necessity to use the brief building period as efficiently as possible. Consequently, the developers decided to manufacture all building components except for the load-bearing concrete structure in their Danish factory before shipping them in containers to Greenland.

Prefabricated elements include the timber roof construction, internal walls and ceilings in painted gypsum panels as well as balconies in galvanised steel and, most notably, large external wall modules. The latter were pre-assembled to a high degree, incorporating thermal insulation, wood-aluminium windows and doors as well as Swisspearl cement composite panels, whose low maintenance requirements and guaranteed temperature resistance of minus 40 degrees made them an ideal choice for this project. The level of prefabrication

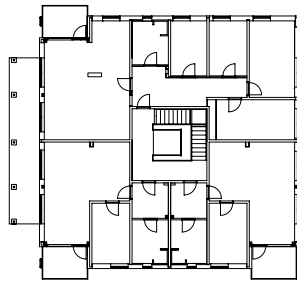

First floor 1:500

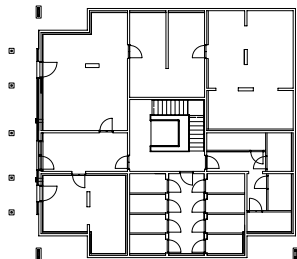

Ground floor

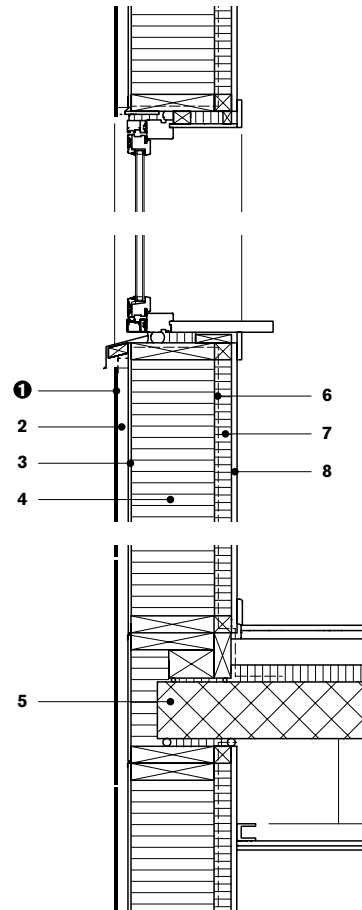

Vertical section 1:20

- 1 Swisspearl® cement composite panel 8 mm
- 2 ventilation cavity, vertical timber batten
- 3 breathable cement composite sheeting
- 4 thermal insulation, timber framed construction
- 5 concrete
- 6 vapour barrier
- 7 thermal insulation, timber batten
- 8 gypsum board

The large external wall modules were prefabricated in a Danish factory, allowing speedy installation on site.





**“FROM THE FIRST SKETCHES TO THE FINAL RESULT,
THE PROJECT GROUP AGREED TO AIM FOR SIMPLICITY
IN DESIGN AND CONSTRUCTION.” IB BLOCH**

meant that installation on site could be carried out at breakneck speed. In fact, it was limited to fixing the panels to the concrete structure and completing the insulation and sheathing of the joints – needless to say that the necessary finishing panels had been previously cut and drilled in the factory.

Designed by Ib Bloch’s multi-disciplinary design consultancy AB Tegnstuen Aps, the residential estate provides 72 rental units distributed in six blocks whose orientation and staggered arrangement were as much determined by the slope of the terrain as by the desire to exploit daylight. Equipped with tables and benches, grill facilities and a children’s playground, a central square serves as a recreational area for residents, creating a sense of place in a thus far mostly undeveloped neighbourhood. The blocks themselves are largely identical and comprise four residential floors rising above a full-story concrete plinth. Each floor accommodates three units ranging from one to four bedrooms and accessed via a central circulation core. Cor-

ner balconies, slanted roof lines and Swisspearl cement composite panels in three different colours add visual interest and break the monotony inevitably inherent in any modular building. *Patrick Zamariàn*

Location Pisissia, Nuuk, Greenland
Client Municipality of Sermersoog, Greenland
Architects AB Tegnstuen Aps, Horsens, Denmark; Ib Bloch
Building period 2009 – 2010
Total contractor and façade construction Atcon Greenland A/S, Nuuk, Greenland
Façade material SWISSPEARL® CARAT, Black Opal 7020, Onyx 7099, Azurite 7041, Coral 7031 and Jade 7051

The result of an effort to create affordable family apartments in Lugano, the six-storey building perched on a steep hillside has separate entrances and an unpretentious design. For economic and construction grounds, but also for ecological reasons, the architect Lorenzo Felder selected wood construction and an envelope of cement composite panels.



Casa Montarina, Lugano, Switzerland

SIMPLICITY AND ENVIRONMENTAL AWARENESS





With a height of 2.7 meters, all the windows are ceiling high and based on the inner room divisions, are distributed fairly regularly over the façade.

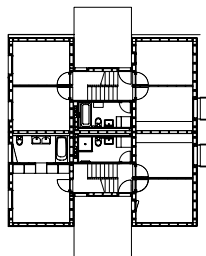

Ground floor 1:500

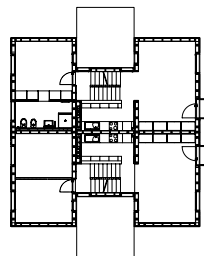

First floor

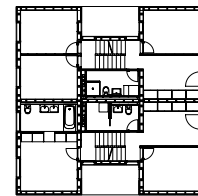

Third floor

“The building is oriented toward people who are critical of the consumer society and unconditional progress – to the benefit of the environment.” Architect Lorenzo Felder tells us animatedly that for him, it is not simply about designing ecological architecture, it is about a deep awareness of our habitat. He stated this to us while standing in front of the building, which stands on a slope in a small valley in the middle of Lugano, the largest city in southern Switzerland. It is a multi-family residence with four 5½-room apartments, where the architect and his family also live. The location marks the border between city and nature. Access is along a quiet street in the residential neighbourhood behind the railway station. Behind the house, wild natural growth stretches out into the notch valley, which has been preserved here in the middle of expanding settlement growth.

As if hewn from the steep hillside, the architect has placed the four units in pairs one upon the other as triplex apartments, meaning each is three storeys high. The rooms on the front and back are set back a half a storey so the eye is drawn to the near view of the greenery or the distant view of the sky. Thanks to the vertical recesses in the structure, there are diverse sight lines, such as from the children’s room over into the dining room. In the centre of the apartment, the kitchen and bathroom are arranged next to the stairwell. A second bathroom is directly off the parent’s bedroom. The lower apartments have a garden patio, the upper apartments a balcony or roof terrace. The tenants could also participate in the decisions on spatial distribution and interior design.

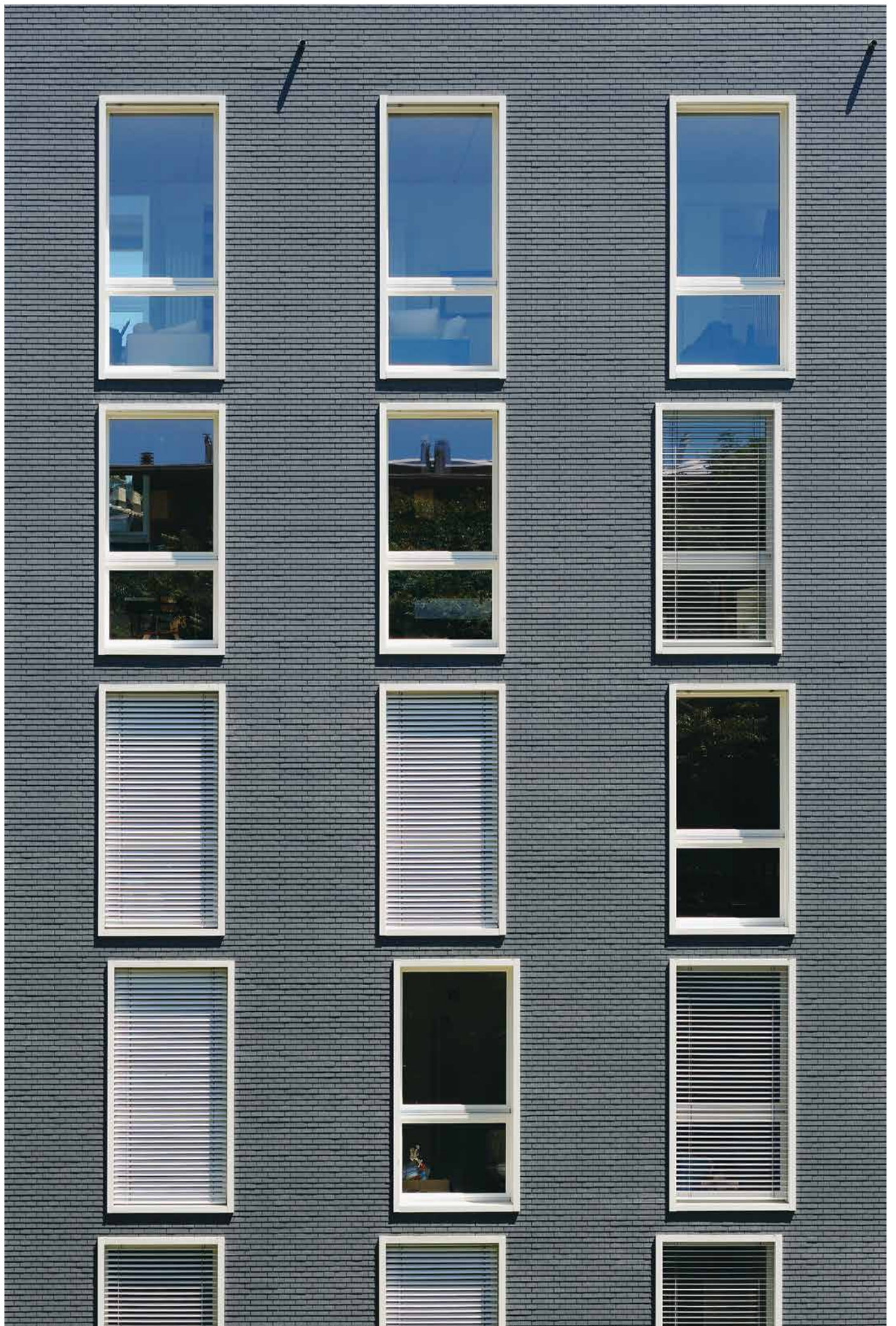

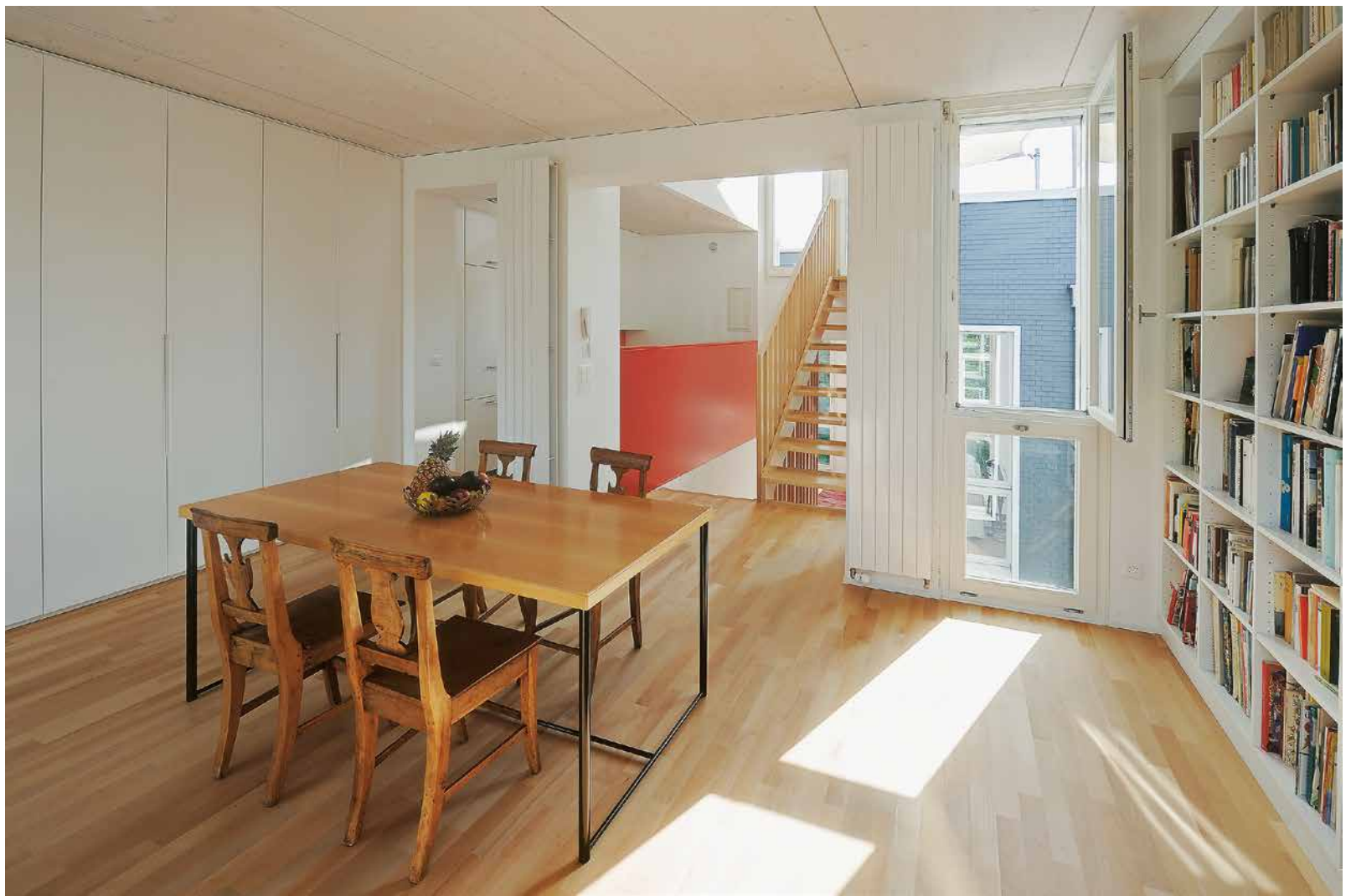

Location Via Aprica 30, Lugano, Switzerland

Client Mimi Lepori Bonetti, Lorenzo Felder, Lugano, Switzerland

Architects Lorenzo Felder, Lugano, Switzerland

Building period 2007 – 2008

General contractor/Engineers Borlini & Zanini SA, Pambio-Noranco, Switzerland

Wood construction and façade construction Laube SA, Biasca, Switzerland

Façade material SWISSPEARL® NOBILIS, Black N 012

The apartment house could be constructed as a wood building, even with six floors, because that is now the maximum permitted height – and a challenge for the wood construction company as well as a pioneer project in southern Switzerland. The usual concrete stairwell could be dispensed with as the apartment entrances are each separate, following the line of the slope. Swisspearl was selected for the façade skin for reasons, among others, of its lighter weight and its fire security. Because of the well-insulated construction techniques and heating provided by heat pumps and earth probes, the building meets the Minergie Eco Standard – also an innovation in the canton of Ticino. In order to avoid grout patterns in the simplest possible façade, Lorenzo Felder selected small-format roof slates, which are drawn over the living spaces like a mantle. *Michael Hanak*

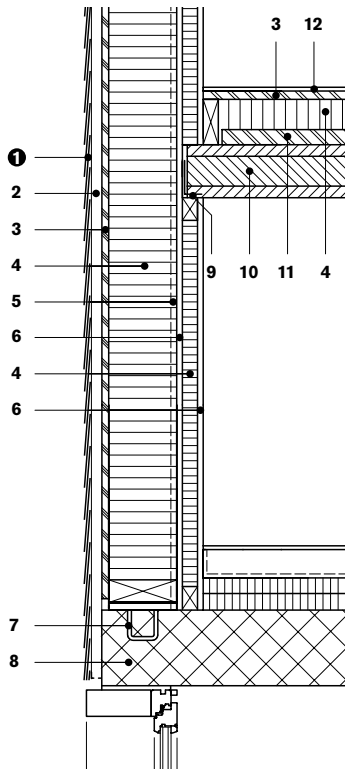
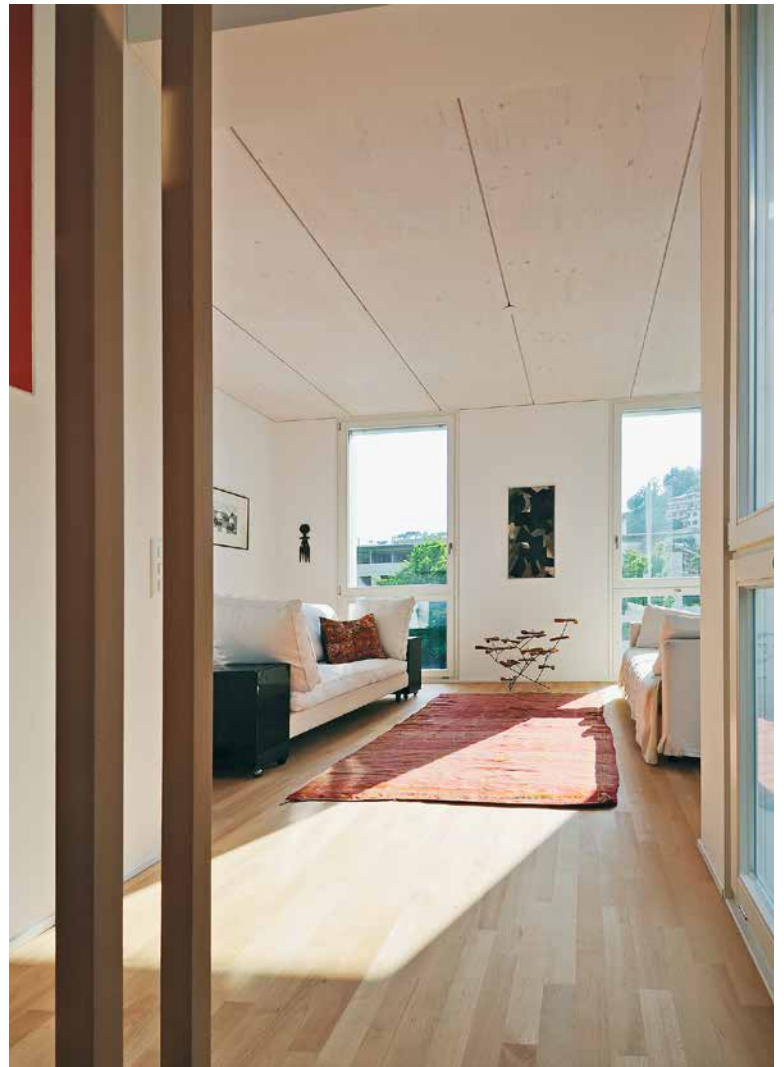

Vertical section 1:20

- 1 Swisspearl® cement composite panel 6 mm, double layer
- 2 ventilation cavity
- 3 oriented strand board
- 4 thermal insulation
- 5 vapour barrier
- 6 gypsum board
- 7 steel anchor
- 8 concrete slab over basement
- 9 steel angle support
- 10 timber structural slab
- 11 cementitious board, sound insulation
- 12 parquet flooring





Semi-detached Houses, Uboldo, Italy

Three Volumes, Six Houses

Each individual house has its own private sun-orientated garden.

Three identical, semi-detached houses form a rhythm of volumes stretched along the periphery of cultivated fields in northern Italy.

This low-density housing development, consisting of three identical semi-detached houses, is situated about twenty kilometres northwest of Milan in the town of Uboldo. Marco Castelletti Architects have echoed the pre-existing pattern of double-storey, free-standing houses in the area as their starting point for this long, narrow site. The first thing that strikes one about the architecture is the manner in which the russet cladding encloses the entire volume in one single gesture. Rather like a mantel, the russet cladding covers the bold form of each house in a unifying manner. Clear symmetry and clean lines give the houses an air of confidence and assuredness. Although the buildings

echo the pitched roof form that symbolises the iconic concept of 'house', albeit in an abstract form, nevertheless, the houses have a futuristic air about them. Each opening is abstracted, each cut deep into the façade. The articulation of the cutaway of the void, clad in white, further emphasises the apertures – as if peeling a fruit and finding the flesh is another colour.

The vehicle entrance to the north is somewhat fortress-like, the black asphalt and metal fencing on the shadow side of the buildings are hard surfaces that convey sturdy protection. The subterranean car park links the three separate houses beneath ground level. This is also where the laundries and wine cellars are located and where the residents can bump into one another and have impromptu chats.



The volumes are marked by the pure symmetry. The cutaway corners are counterbalanced by the cut-out balconies on the first floor.

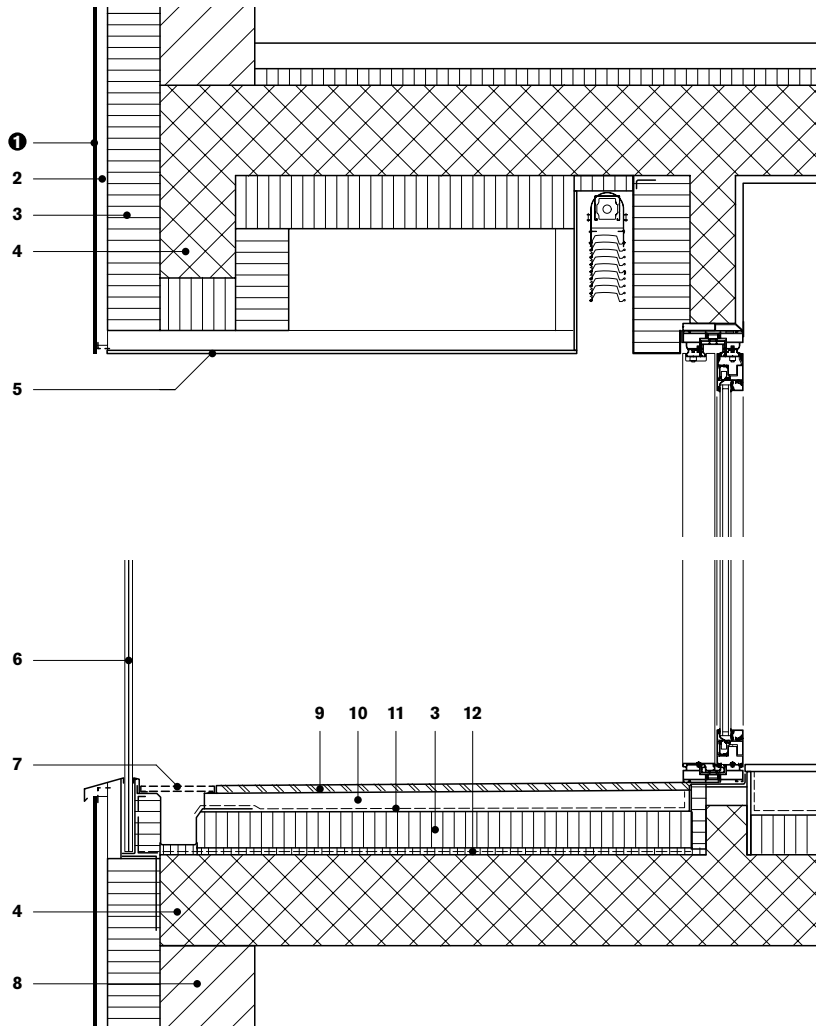

Vertical section 1:20

- 1 Swisspearl® cement composite panel 8 mm
- 2 ventilation cavity, vertical sub-framing
- 3 thermal insulation
- 4 concrete
- 5 suspended ceiling
- 6 glazed balustrade
- 7 grating
- 8 brickwork
- 9 stone floor
- 10 cement screed
- 11 waterproofing
- 12 vapour barrier

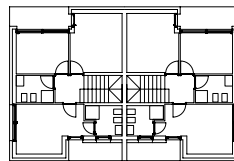
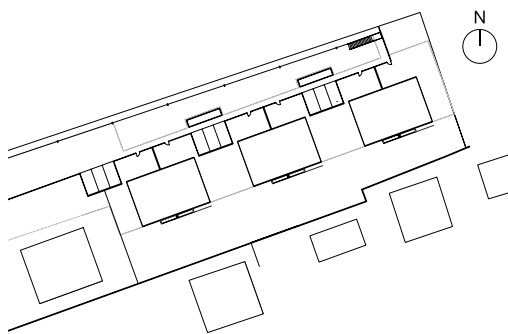

First floor 1:500

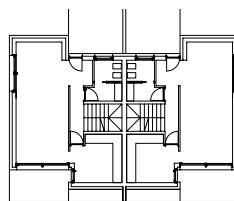

Ground floor

Location 468 Via Primo Maggio, Uboldo, Italy
Client Rigamonti Francesco Spa, Erba, Italy
Architects Marco Castelletti, Erba, Italy
Building period 2010–2011
General contractor and façade construction Rigamonti Francesco Spa, Erba, Italy
Façade material SWISSPEARL® CARAT Coral 7030, 7032, 7033, Sapphire 7060, Coral 7030R, 7032R, 7033R

As the houses are freestanding and only share one party wall, the interior spaces have the advantage of having natural light on three sides. The layout of the houses is straightforward with communal spaces, kitchen and open-plan dining and living rooms on the ground floor as well as a corner patio that spills out onto the private gardens. These south-facing gardens are cordoned off with hedgerows for privacy. The upper level accommodates two bedrooms, one single, whilst the other double-room has its own terrace overlooking the garden below. The rhythm set up by the trio of russet red houses makes a strong visual statement along the Via Primo Maggio. *Anna Roos*



**“THE MATERIALS WERE CHOSEN DUE TO THEIR EASE OF CONSTRUCTION,
AS WELL AS THEIR AESTHETIC QUALITIES AND ENVIRONMENTAL
PERFORMANCE.” MARCO CASTELLETTI**



Swisspearl panels
enclose the entire form
in russet red.



Reinterpreting the formal language of the neighbouring houses, the two floors of this modest holiday home in Sveti Martin show a pronounced contrast in both material and form. By rotating the upper level, architect Vedran Pedišić created a first floor terrace along with a sheltered garden patio, thus expanding the living space beyond the confines of the building.

House GV-17, Sveti Martin na Muri, Croatia

REDEFINING THE ARCHETYPE





The sheltered garden terrace serves as a spatial and functional extension of the kitchen.

Discovered one hundred years ago by a British-Hungarian company drilling for oil, the thermal springs of Sveti Martin na Muri in the north of Croatia have experienced an intense period of tourism development. The past decade has attracted an increasingly international clientele and now requires more than two hundred staff.

The major building projects of the revived resort, most notably its sports hall and a large hotel complex, were designed by the architects of Sangrad in 2009 (see SWISSPEARL ARCHITECTURE 10 and 11). Earlier this year Vedran Pedišić, the head of the practice, completed a weekend home in a residential area adjacent to the resort. Flanked by an orchard, the two-storey house commands magnificent views of the nearby forest and, nestled within it, the buildings he designed.

Built for a modest 100,000 euros, Pedišić dispensed with expensive extras, such as a basement or a garage, focusing instead on the spatial qualities of the interior. Almost medieval in concept (though by no means in execution), the central hallway constitutes the heart of the house and connects directly to all other rooms. As extended living area, it essentially occupies the entire ground floor apart from the vestibule and lends a cer-

tain grandeur to the house despite its limited size. Taking advantage of the slope of the terrain, the actual living room is lowered into the ground, benefitting from a higher ceiling than the remaining rooms and opening through full-height glass doors to the garden lawn to the west and the patio to the south.

The dining-room-kitchen opens to the hallway rather than the living room, thus reinforcing the typological connotation of a medieval hall centred upon the common hearth. Equipped with bar seating and built-in shelves, the kitchen animates the hallway, turning it from a mere circulation area to a meeting space for the whole family. In fact, this space not only spreads out horizontally, but vertically as well, as the stairs lead up to an open study lounge with access to a first floor terrace. The two bedrooms, each complete with an ensuite bathroom, are located symmetrically to either side of the lounge.

The formal expression of the building contravenes the spatial unity inside, given that the two storeys are articulated in a diverging manner. Seeking to “redefine the archetypal idea of a family house”, the architect seemingly merged two building types within the same structure: a modernist house at ground level and a barn



Flanked by an orchard, the house commands a magnificent view of the nearby forest.

cottage balanced on top of it. The different façade materials accentuate the hybrid nature of the building. Contrasting the white plaster of the lower part, Pedišić chose dark Swisspearl cement composite panels for the walls and the pitched roof of the upper portion. By rotating the latter, he moulded an intricate volume protruding from either side of the building. Toward the access road, a small canopy marks the entrance to the house; to the rear a more substantial overhang shelters part of the terrace in order to allow outdoor activities throughout the year. *Patrick Zamariàn*

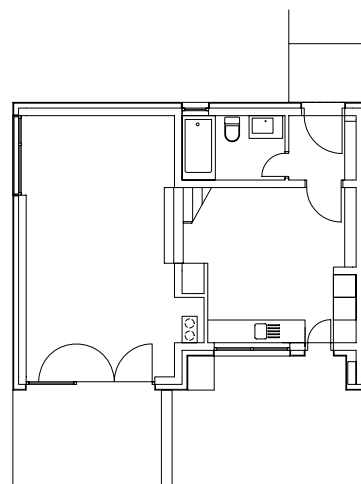

Ground floor 1:200

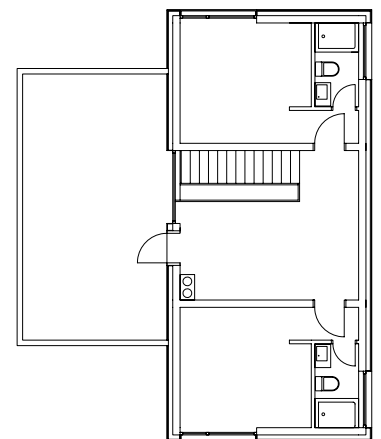

First floor

“IN ORDER TO REDEFINE THE ARCHETYPICAL, TRADITIONAL HOUSE IN THE AREA, WE STARTED FROM THE SIMPLEST IDEA OF THE HOUSE AND THEN ROTATED ITS UPPER PART.” VEDRAN PEDIŠIĆ

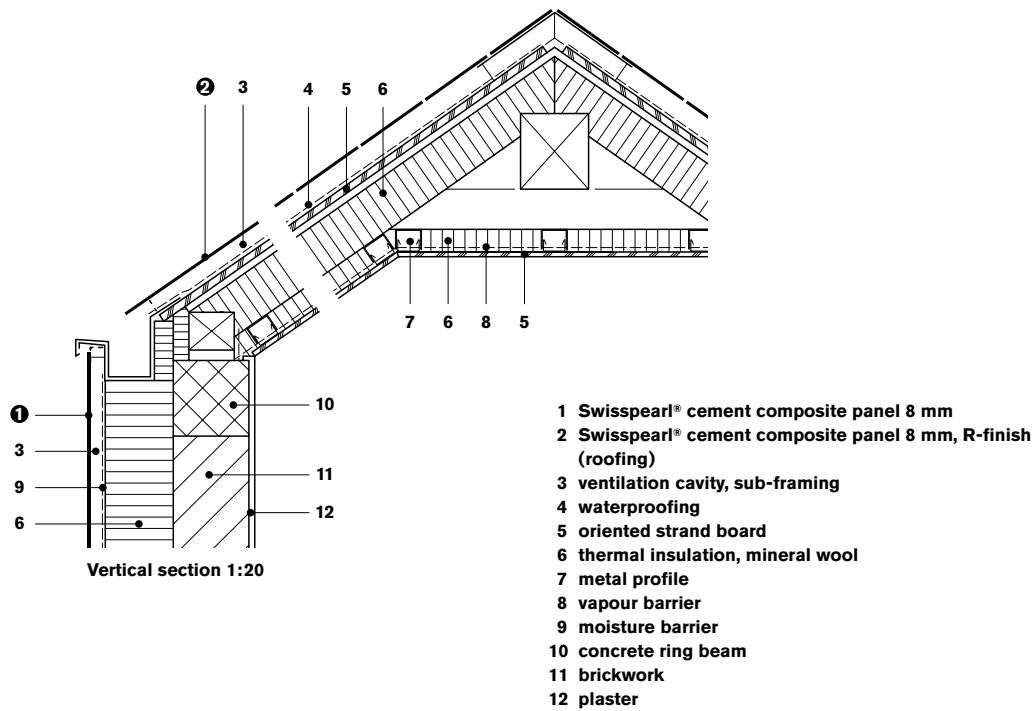

Equipped with bar seating and built-in shelves, the kitchen animates the hallway, turning it from a circulation area to a meeting space for the family.

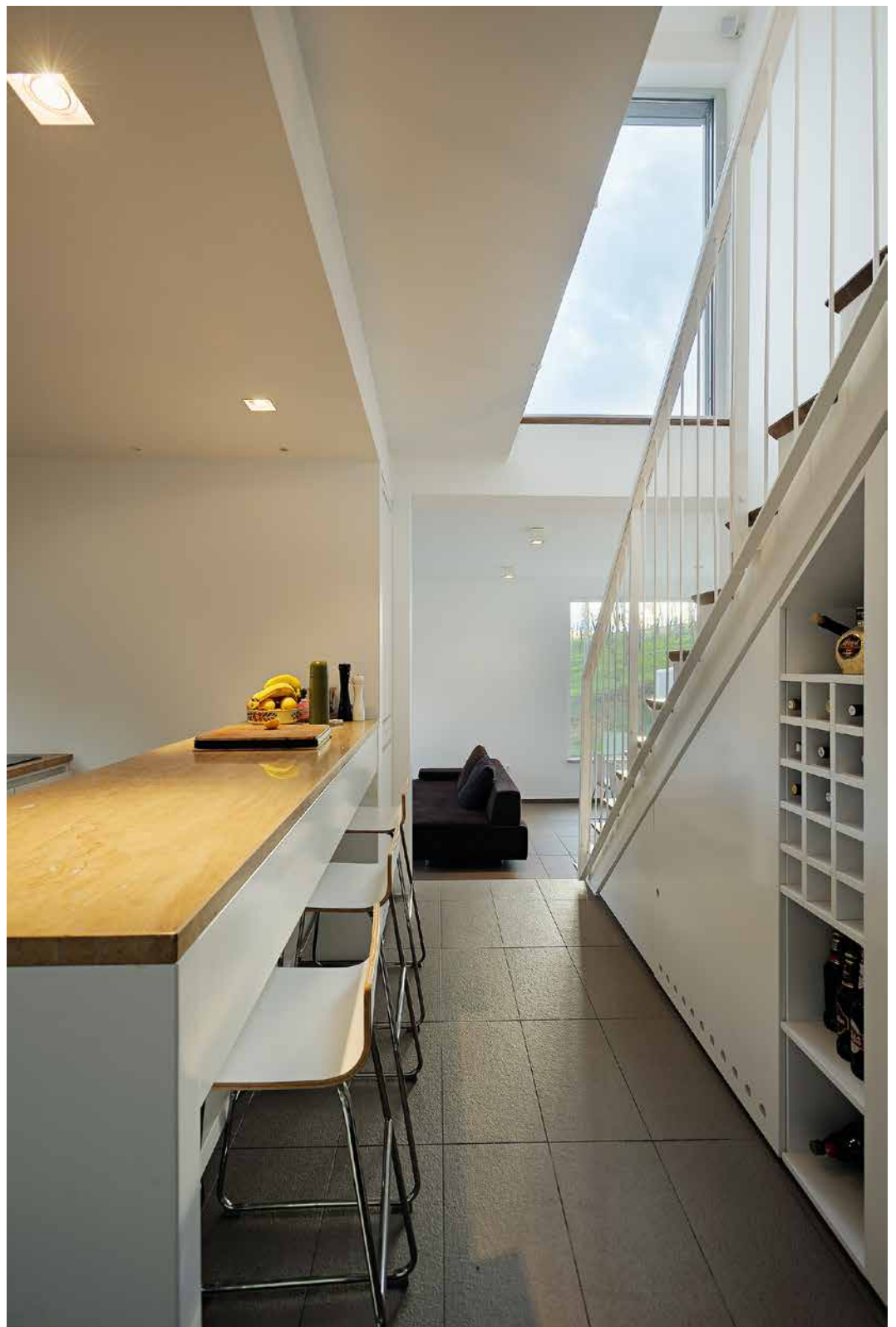

“THROUGH THIS GESTURE OF ROTATING THE UPPER FLOOR, WE CREATED A ‘HOVERING’ HOUSE, AND OUR CHOICE OF MATERIAL STRESSES THE FLOATING NATURE OF THE BUILDING.” VEDRAN PEDIŠIĆ

Location Sveti Martin na Muri, Croatia

Client Private

Architect Vedran Pedišić d.i.a, Zagreb, Croatia

Building period 2009–2010

General contractor Međimurje Graditeljstvo, Čakovec, Croatia

Façade construction Gecko d. o. o., Zagreb, Croatia

Façade material SWISSPEARL® NOBILIS, Grey N 213

Talking with Vedran Pedišić, Zagreb, Croatia



Vedran Pedišić was born in 1969. After graduating from the Faculty of Architecture at the University of Zagreb in 1997, he worked as a project manager for a big Croatian building company. In 2004, he founded his own architectural firm Sangrad, which he currently runs alongside six collaborators.

When we last spoke three years ago (see SWISSPEARL ARCHITECTURE 11), you mentioned that the sport resort was not yet complete and that you were about to build a series of small houses close to the golf course. Is this one of these houses?

Yes, it is. There are 17 houses in total, which is why this one is called GV-17. It is one of four different types of houses that constitute the resort. The other types are different in that they were largely built according to the vision of the investors. In a way, this one is more traditional, more connected with the existing houses in the area.

What do you mean?

We wanted to do something that originated from the site, so we used the existing houses as a prototype and tried to reorganise it. The traditional houses in this region usually have a ground floor made of brick and covered in plaster, and an upper floor made of wood. We took this idea as the starting point for our own house. We used this archetypal house and we redefined it.

The house was originally designed in 2006, but not completed until 2013. This seems a very long time for a private home.

Yes, there were many investors, and this area was without any infrastructure at all, so we had to do everything from scratch – all the streets, and all the infrastructure facilities, such as gas and water pipes. Also, the other investors had different ideas, so it all came about a bit slowly.

The house itself has a simple, yet interesting spatial concept. It looks to me like one large open living zone spread over two floors. Can you explain how it works?

Yes, the lower floor is mostly living space: dining area, living room, and kitchen. All these spaces are linked to the outside areas surrounding them. Everything, apart from the bathroom, is connected to nature in a way. The upper floor is different. Here we have two bedrooms enclosing a more private living room that leads out to the terrace. It is like a retreat in a way – a more peaceful kind of living space. It is the sort of space that you use before you go to bed. There is no TV in the bedrooms, but there is one here. The architecture and the spaces correspond to our idea of daily life. We wanted to make things as simple as possible, without too much detailing.

In terms of appearance, the building looks like two different types of house piled on top of each other. What was the idea behind it?

In order to redefine the archetypal, traditional house in the area, we started from the simplest idea of the house and then rotated its upper part. This is the main idea, and it allows both the entrance and the ground floor terrace of the building to be covered. The latter really is a functional and spatial extension of the kitchen and features a built-in grill. Therefore, when the sliding doors are open, we can use the kitchen both inside and out. In addition, by turning the house, we create this terrace on the upper floor in a position from where everything is visible: the hotel, the other buildings, the golf course, the orchard, the woods. It is a beautiful – probably *the* most beautiful – space.

You designed the nearby hotel complex in a way that it can never really be appreciated in its entirety from any one side. It constantly changes its appearance as you walk around it. The same seems to be true for this house.

Yes, that is always the case with our projects. Every side has its own logic. In this house, the eastern façade is orientated towards the road and therefore mostly closed with only two bathroom windows on the upper floor. The south front is very open since the terrain is sloping, thus allowing the best views of the surroundings and the



nearby orchard. The northern part, in turn, is rather quiet again, featuring only the entrance door and one window upstairs.

The materials and formal expression change from the lower to the upper floor with the latter clad in Swisspearl panels.

Why this alteration?

On one hand, it was a reaction to the architecture of the neighbouring buildings. On the other, through this gesture of rotating the upper floor, we created a ‘hovering’ house, and our choice of material stresses the floating nature of the building. We wanted to use as few materials as possible and therefore connect the walls of the upper level with the roof. The Swisspearl panels offer a very practical way of doing this. This is also the reason why we used a darker colour. In general, the traditional houses in the area look a little bit ‘hard’ as it were. We designed a house that, in terms of material and colour, appears hard; however, the shape of the upper floor and the way it is positioned on the lower floor suggest lightness. We wanted to emphasise this dual contrast – a softer ground floor in white plaster as opposed to a somewhat harder upper floor, which, in turn, appears light by floating above the lower level.

You have, in recent years, become something of an expert for Swisspearl panels, having used the material in different contexts and for a variety of building tasks. In general, where do you see the advantages of Swisspearl?

Why do I like this material? First of all, it is a natural material – it is cement after all. For ecological reasons, we like to make ventilated façades and use natural materials in order to minimise the building’s impact on the environment. Secondly, this is a material with very good durability, and it is easy to replace individual panels if one gets damaged. With plaster, if one piece of the wall is in bad shape you have to renew the entire façade, whereas with Swisspearl you can just replace that one single panel. Thirdly, the price makes

it an economical solution; and finally, I like the sort of colours you get with Swisspearl. The type that I have used (Nobilis) in particular seems to contain a whole mixture of colours. I don’t like ‘pure’ colours, i. e. colours that always look like on a colour chart – pure red, pure blue, etc. I much prefer it when colours change their appearance slightly over the course of the day. Sometimes the panels appear very dark, sometimes much lighter, always depending on the sunlight.

You mentioned the durability. As you can see two of your major Swisspearl buildings, the hotel and the sports hall, from the terrace of the new house, what can you tell us about the performance over time of the panels? How do the façades look half a decade after they were built?

They look great. They look really, really good, as if they had been made yesterday. I hope I will be able to tell you the same thing in another five years’ time!

Building a small home like this has the advantage that you are usually in full control of the building process. Are you satisfied with the outcome?

Well, yes, to some degree. Given the chance, I would do some things differently.

You are never really happy, are you?

No, you shouldn’t be happy as an architect. Otherwise, you have no incentive to make it better next time. I am satisfied ... mostly [laughs].

Interview by Patrick Zamariàn

Sonya Perica Residence, Sydney, Australia

Bay Watch



With its sleek Swiss-pearl-clad façades, this duplex in a North Bondi residential neighbourhood stands out among the mostly conventional architecture.

Australian architect Jessica Matson has inserted a strikingly modern duplex house into a popular Sydney suburb, making full use of the location on a steep hill.

Just like Sydney's iconic Opera House, the skyline-defining Harbour Bridge constructed in 1932 or the historic neighbourhood of The Rocks, Bondi Beach counts among the city's most visited spots. Popular today with surfers and swimmers alike, the picturesque bay was settled in the 19th century. Having long been a working class suburb, in recent years it has attracted a wealthier population – though still keeping its multicultural flair. North Bondi provides exquisite views of the city and the Tasman Sea. On one of the coveted slopes of this coastal suburb, Australian architect Jessica Matson has recently built a duplex that stands out from the rest.

The owner had bought a steeply sloping strip of land with an older residential structure on it. The latter was unsuitable for her needs, however, and so it was decided to build something completely new that would take advantage of the stunning views. "We wanted to create a light contemporary structure that responded to Bondi's beachside environment and culture," said Jessica Matson. She opted for a three-storey structure that would make full use of the restricted space, with a top and bottom apartment that would share the middle floor. "I wanted to build an environmentally sensitive house with excellent natural light and ventilation," the architect added.

With a masonry plinth bearing a lightweight construction above, the question was which façade material to choose. "The owner was keen to use a long-lasting and low-maintenance product for the upper level." Jessica Matson continued: "One of my colleagues had recently used Swisspearl in another Sydney residential project, so together with the owner, we investigated to see if it would suit our needs."

It did, and the duplex in North Bondi got its ventilated façade in two shades of Swisspearl panelling. The combination of the cement composite panels with glass louvres provides passive cooling and takes advantage of the evening sea breezes in the hot Australian summers, when the upper levels of buildings tend to overheat. The visual result is a decidedly contemporary dwelling that stands out among its neighbours, but at the same time looks very much at home in Sydney's marine atmosphere. *Mirko Beetschen*



The combination of a façade in cement composite panelling and glass louvres make for a well lit and ventilated structure, sustaining the harsh marine climate.

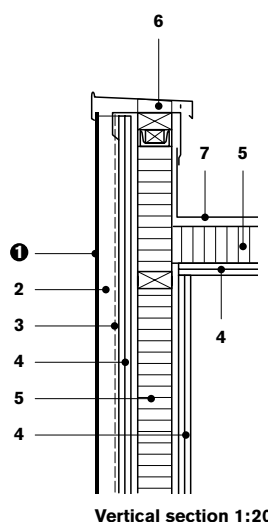

- 1 Swisspearl® cement composite panel 8 mm
- 2 ventilation cavity, vertical framing
- 3 moisture barrier
- 4 gypsum board, double layer
- 5 thermal insulation, stud framing
- 6 ventilation cavity
- 7 folded steel box gutter

“CHOSEN FOR ITS MINIMAL MAINTENANCE REQUIREMENTS, THE SWISSPEARL FAÇADE CONTRIBUTES TO THE UNIQUE PERSONA OF THE HOUSE.” JESSICA MATSON

Location 18 O'Donnell Street, North Bondi, Sydney, Australia
Client Sonya Perica, Sydney, Australia
Architect Jessica Matson, Marrickville, Australia
Building period 2012–2013
General contractor and façade construction CLC Constructions, Gympie Bay, Australia
Façade materials SWISSPEARL® CARAT, Sapphire 7060 and Onyx 7099

“THE PROPERTY OWNER IS THRILLED WITH BOTH THE APPEARANCE AND THE PERFORMANCE OF THE CLADDING SYSTEM.”
JESSICA MATSON

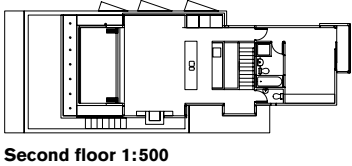

Second floor 1:500

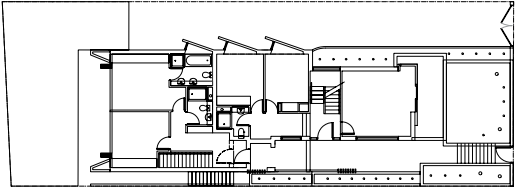

First floor

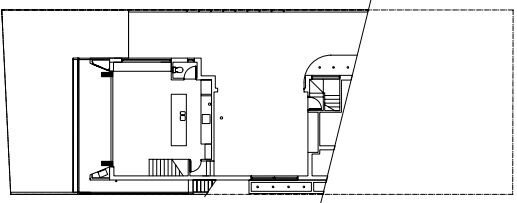

Ground floor



House M2, Bozen, Italy

Climate House



Flush floor surfaces create a seamless transition from the living room to the pool area.

A multi-layered envelope, high-performance glazing and a photovoltaic installation on the roof significantly reduce energy expenditure in this luxury residence. The two apartments occupy an entire floor each and have access to spacious outdoor areas as well as a shared underground car park.

Embedded in a magnificent alpine setting, but Mediterranean in feel, House M2 on the outskirts of the South Tyrolean capital of Bozen echoes the cultural ambiguity of this German-speaking region in the north-eastern part of Italy. Completed in 2012 by local practice monovolume architecture + design, the structure comprises a full-size basement and two separate apartments, one on each of the two upper floors.

Towards the access road to the north and east, the building presents itself as a compact volume punctu-

ated by window openings. The south and west fronts, in contrast, boast extensive glass surfaces facing, respectively, the pool area at ground level and a large terrace on the upper story. An alteration in cladding material from light grey plaster to white Swisspearl cement composite panels accentuates the two separate units in a building that might otherwise be misconstrued as a single-family home.

Both units are roughly square in plan; the upper one, however, is considerably smaller and shifted out of the centre, thus creating a stepped section and – in connection with cantilevering floor slabs – adding a strong horizontal emphasis to the building. The interior design mirrors the minimalist exterior with a combination of dark stone and hard wood floorings set against clinically white wall surfaces and kitchen fittings. Flush



A change in cladding material from light grey plaster to white Swisspearl panels accentuates the two separate units of the building.

floor surfaces suggest a seamless transition from the living room to the outside areas, while slender black window frames, frameless glass railings and Italian design furniture add to the refined look of the apartments.

Although they are different sizes, the two units feature a similar layout based on a distinction between day and night zones. Arranged in an L-shape along the northern and eastern sides of the building, the ground floor accommodates two bedrooms, a study and two bathrooms as well as a private staircase leading to the underground car park. The living space overlooking the patio is divided into a generous dining kitchen to one side, and a lounge with fitted shelves to the other. The distinction between public and private spaces is clearly articulated in the upper apartment where an internal wall cuts through the entire length of the apartment,

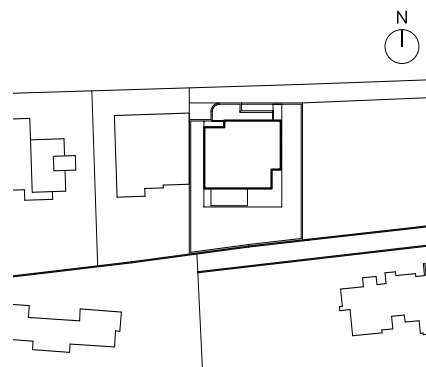

“A CONTINUOUS WALL, WHICH PASSES PARALLEL TO THE EXTERIOR WALLS, SEPARATES THE NIGHT AREA FROM THE DAY AREA.” MONOVOLUME

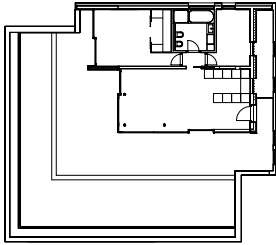

First floor 1:500

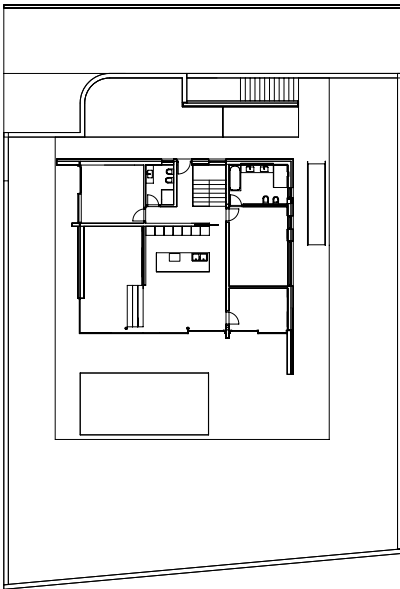

Ground floor

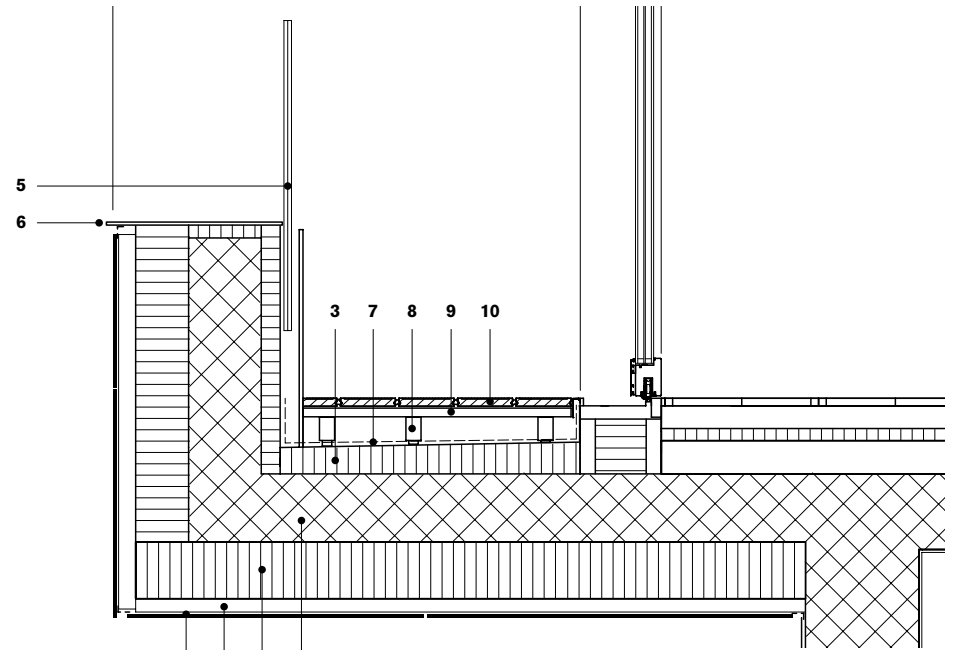
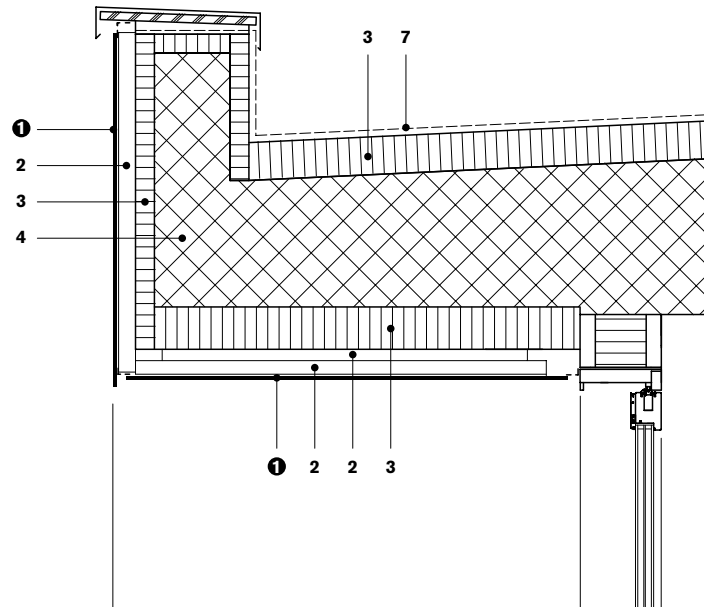

Vertical section 1:20

- 1 Swisspearl® cement composite panel 8 mm
- 2 ventilation cavity, sub-framing
- 3 thermal insulation
- 4 concrete
- 5 glazed balustrade
- 6 plastic board
- 7 waterproofing
- 8 rubber support
- 9 aluminium sub-framing
- 10 wooden floor

separating two bedrooms and a bathroom to the north from a large combined kitchen, dining and living space to the south.

House M2 has been awarded a category A classification by ClimateHouse, a regional agency that certifies buildings in terms of their energy consumption. Key sustainable features include the highly insulated envelope, rooftop photovoltaic panels and triple glazing throughout. The floors are composed of a thick layering of insulation materials, measuring nearly one metre between the ground floor and the basement and allowing the designers to carve out a lowered lounge zone without impacting on the ceiling heights underneath. Likewise, the area of the terrace immediately adjacent to the upper floor living room lies lower than the peripheral one, thus offering a great degree of privacy to both residents. *Patrick Zamariàn*

**“THE PLASTERED BASEMENT
SERVES AS PEDESTAL
FOR THE SMALLER UPPER
FLOOR, WHICH IS COVERED
BY CLADDING SHEETS.”
MONOVOLUME**



Location San Maurizio, Bozen, Italy

Client Private

Architects monovolume architecture + design (Patrik Pedó, Juri Pobitzer, Konrad Rieper; in collaboration with Simon Constantini, Luca Di Censo), Bozen, Italy

Building period 2011–2012

General contractor Kofler Baur srl, Bozen, Italy

Façade construction Trimont GmbH, Leifers, Italy

Façade material SWISSPEARL® CARAT, Onyx 7090

House Hindås, Gothenburg, Sweden

Nestled between Lake and Forest



The house is nestled between the coniferous forest and the lake.

Set between deep green pine forests and the Västra Nedsjön Lake inland from Gothenburg, this double-storey, single-family house sits comfortably in its rural setting. The building is perched above a rock bed, elevating it above the landscape and optimising the surrounding vistas. The rich backdrop of verdant nature surrounding the house forms a strong contrast to its simple, cabin-like architecture, which creates a retreat from the hubbub and noise of city life. The building consists of an orthogonal volume, the corner of which has been sliced away to create an elevated balcony that opens out from the kitchen and living spaces on the first floor. The balcony wraps around the house cantilevering over the southwest façade to create a sheltered terrace for the office and guestrooms on the ground level below.

The choice of cladding material expressed the client's desire for a contemporary house. The large-format, gunmetal grey Swisspearl cement composite panels convey the modern, sleek image that was sought. A quirky accent to the façades is the cantilevered steel projection nook on the northeast façade that creates a niche for the bathtub.

The projecting gable-end on the façade obscures the monopitch roof, maintaining the integrity of the orthogonal box. Raised timber terraces that project from the house provide an interface from the interior to the exterior. Generous, large-scale windows that lie flush with the façade allow copious amounts of daylight into the house as well as a view overlooking the dark lake waters below. *Anna Roos*

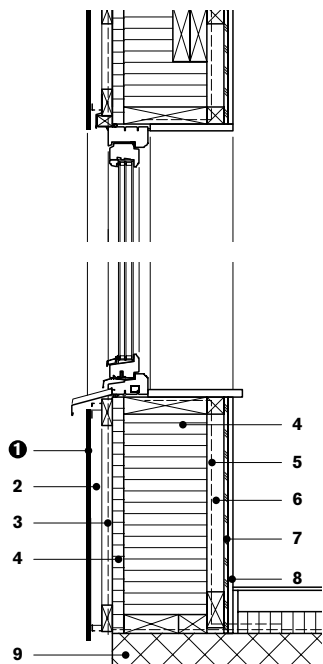

Vertical section 1:20

- 1 Swisspearl® cement composite panel 8 mm
- 2 ventilation cavity
- 3 moisture barrier, horizontal batten
- 4 thermal insulation
- 5 vapour barrier
- 6 horizontal batten
- 7 oriented strand board
- 8 gypsum board
- 9 concrete



House Hindås seems to hover above the rocky site, with raised timber decks that slide over the uneven terrain.

“TO BLEND IN WITH THE SURROUNDINGS, A DARKER TONE OF GRAPHITE WAS CHOSEN TOGETHER WITH SHEET METAL PARTS. AS AN ARCHITECT, I FEEL VERY HAPPY WITH THE RESULT.” STEFAN RUPERT, INOBI AB

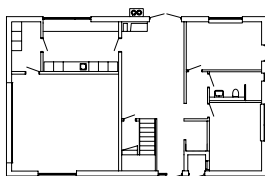

Ground floor 1:500

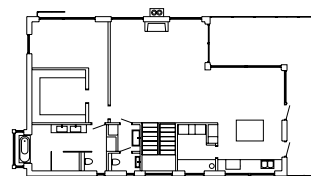

First floor

Location Takkullevägen 77, Hindås, Gothenburg, Sweden

Client Thomas and Vivianne Hult, Gothenburg, Sweden

Architects Inobi AB, Gothenburg, Sweden

Building period 2008

General contractor and façade construction Willa Nordic, Sweden

Façade material SWISSPEARL® CARAT, Black Opal 7020

This house allows the family to spill out from the open-plan dining and living area onto the outdoor patio and pool area, creating a cool place to take shelter in a hot climate.



Single-family House, Parede near Lisbon, Portugal

LIGHT, BRIGHT, WHITE



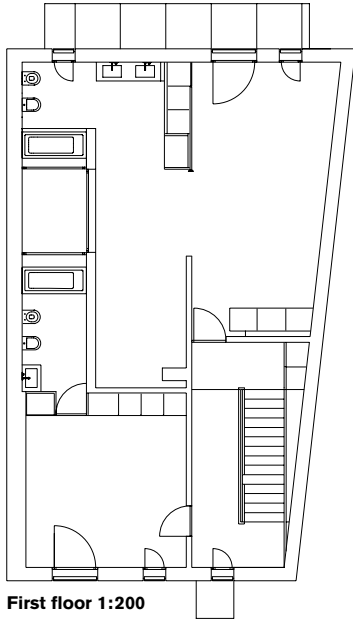

First floor 1:200

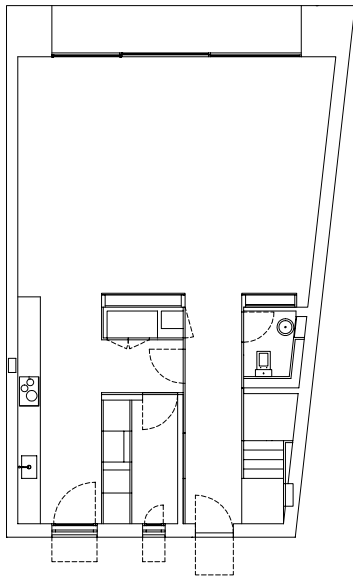

Ground floor

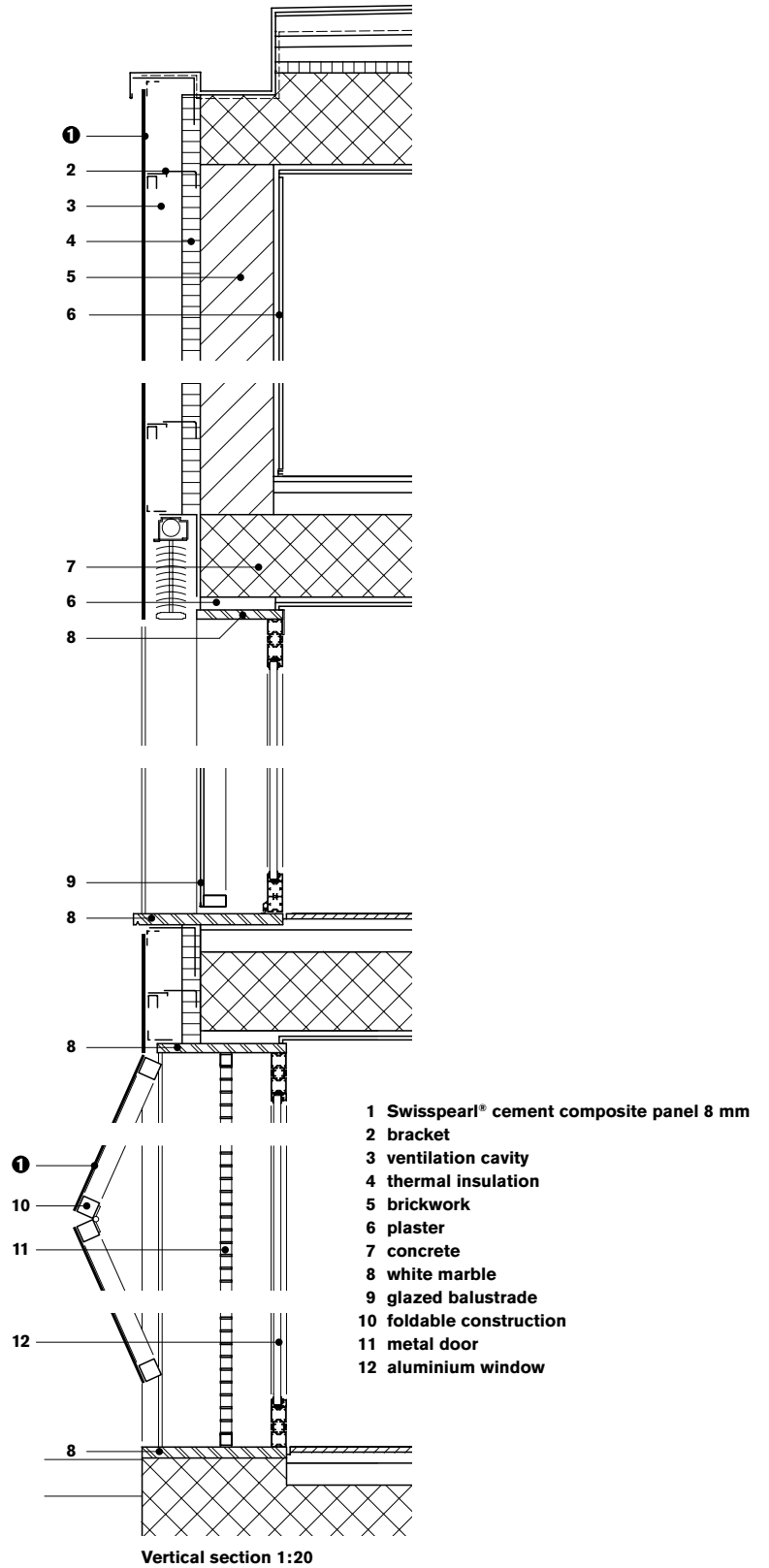

- 1 Swisspearl® cement composite panel 8 mm
- 2 bracket
- 3 ventilation cavity
- 4 thermal insulation
- 5 brickwork
- 6 plaster
- 7 concrete
- 8 white marble
- 9 glazed balustrade
- 10 foldable construction
- 11 metal door
- 12 aluminium window

Vertical section 1:20

“WE BELIEVE THAT THE NEW CONSTRUCTION SHOULD BE MARKED OUT WITH THE ALIGNMENTS OF THE ADJACENT HOUSE, NAMELY THE BUILDING’S HEIGHT, VOLUMETRY AND THE FLOOR LEVELS OF THE MAIN FAÇADE.” HUMBERTO CONDE



This elegant, triple-storey, single-family house located near Lisbon in Portugal sits on an elongated, wedge-shaped site that fans open to the outdoor spaces drawn out to the west. The site is subdivided into four distinct zones: the arrival and parking area, the house itself, the outdoor patio with swimming pool and finally, the garden at the back of the site.

The play of vertical, floor-to-ceiling openings in the façade and clean, white cladding creates an appealing aesthetic. Vertical concertina shutters close off the ground floor façade, making it impenetrable; a clever tactic that provides both privacy and security. White Swisspearl cement composite panels correspond to the three floor levels, allowing one to read the floor slab levels behind the elevations. The vertical accent of the single, delicate tree, together with the protruding canopy

above the entry door demarcates a covered entry zone in front of the main entrance.

Although the architecture of the house contrasts with the surrounding houses, the fact that it responds to the height lines of the neighbouring house to the south, corresponding to the lines of the eaves and floor levels, ties it into its surroundings. The layout of the house is clear and logical with the communal zones – kitchen, living and dining – situated on the ground level, and the bedrooms on the upper two floors. Working one's way up from the ground floor: the open-plan dining and living room is a sizeable open plan space of 52 m² that can be furnished in a variety of ways. Large, sliding doors allow the space to extend outdoors to the covered patio and pool, merging indoors and outdoors.



Vertical concertina shutters, enable the ground floor façade to be shut off from the street.

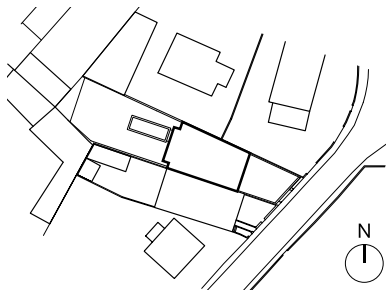

The bright stairwell, which has two elongated openings, is like a light well, vertically slicing through the building. An interesting feature in this tall space is the window openings cut into the internal façade that overlooks the stairwell, creating unusual diagonal internal views into the bedroom and intricate light reflections, although perhaps foregoing a level of privacy. Ascending to the first floor that accommodates two bedrooms, the larger, elongated room is used as a study space, while the other smaller square room is a child's room. Each room has its own sleek, white en-suite bathroom. A generous walk-in cupboard and courtyard mini-garden, containing a single, bonsai-like tree, give these spaces a special quality. There is an interesting flow of space between the rooms.

The main bedroom crowns the house and forms the 'penthouse' on the uppermost floor. This volume has been clad in large-format grey Swisspearl cement composite panels that double as shutters on the double-door openings. When the shutters are closed, the volume reads like a pure abstract volume. This upper level is set back, thereby reducing the scale of the house on the garden side. The L-shaped main bedroom has an en-suite bathroom tucked into the corner junction with its own door opening onto the broad terrace that overlooks the pool and garden below. Overall, this is a light, spacious house devoid of clutter and bathed in masses of natural light. *Anna Roos*

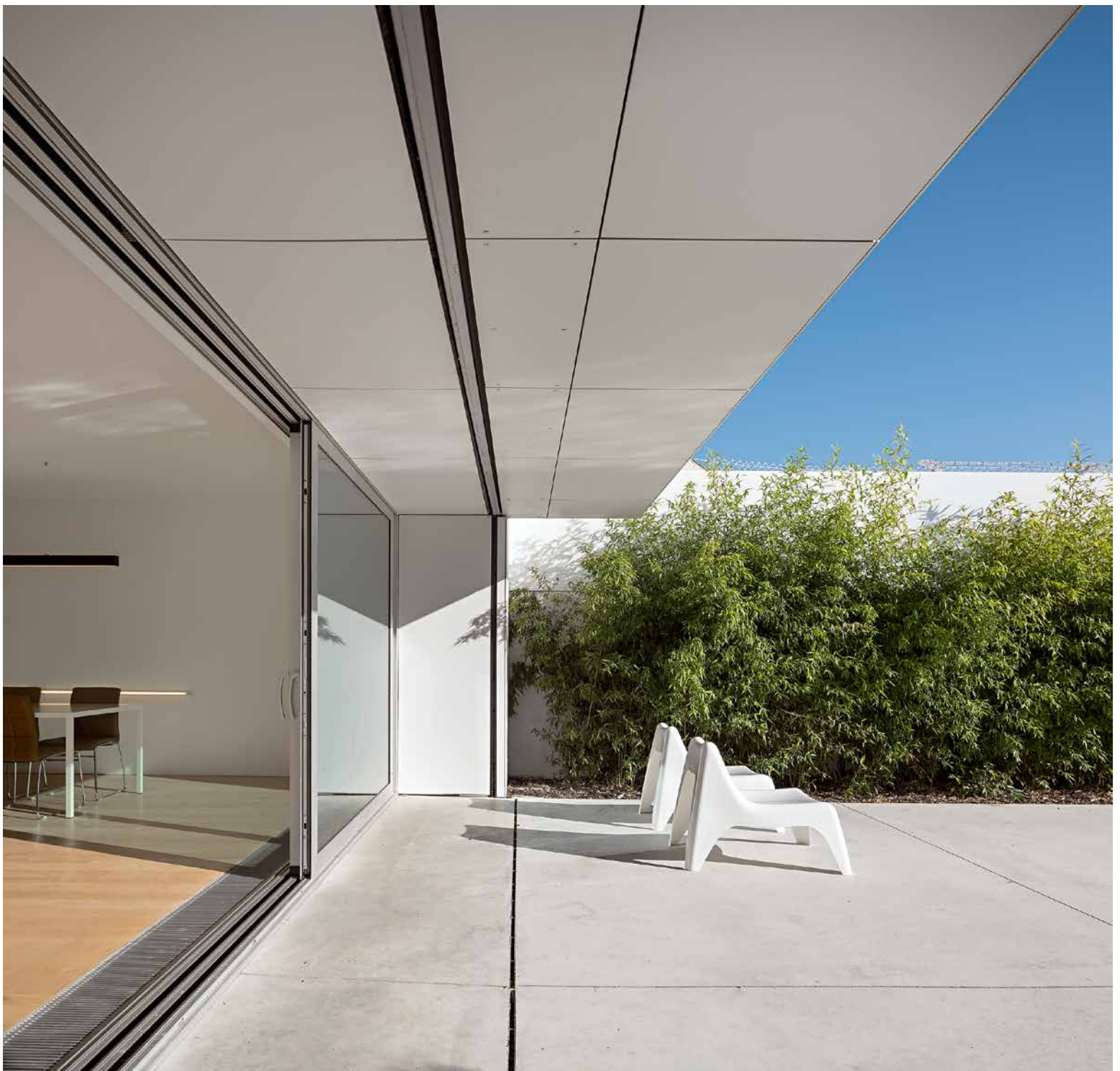

“THE BUILDING SHOULD PROMOTE A DIALOGUE BETWEEN THE SURROUNDING AREA WITH A LANGUAGE OF CONTRAST IN ITS IMAGE AND SHAPE.” HUMBERTO CONDE

Location Rua 31 Janeiro, 11, Parede, Portugal

Client and architect Humberto Conde, Lisbon, Portugal

Building period 2007 – 2013

General contractor HRA-Lisboa, Humberto Conde, Lisbon, Portugal

Façade construction Stonarte Lda., Vila Nova de Gaia, Portugal, Portugal

Façade material SWISSPEARL® CARAT, Onyx 7099 and Sapphire 7060



Coinciding with its fiftieth anniversary, the opening of the ÉMI Construction Knowledge Center marks the first step in the conversion of a former industrial zone into a hub for building research and innovation. The three-storey office structure incorporates an abundance of sustainable features, not the least of which is its ventilated and super-insulated Swisspearl envelope.

ÉMI Construction Knowledge Center, Szentendre, Hungary

THE INCUBATOR HOUSE





Construction accounts for forty per cent of total energy consumption in Europe, and it is estimated that the implementation of sustainable building methods could potentially reduce this expenditure by more than a tenth. Unsurprisingly, the European Union increasingly channels its development funding into projects that address the interlinked issues of environmental pollution, global warming and resource scarcity. One such project is the transformation of an obsolete and partially derelict industrial zone in the Hungarian town of Szentendre into a state-of-the-art ‘innovation park’. A brainchild of ÉMI, the country’s leading non-profit organisation concerned with quality control and innovation in building, the park will provide a regional base for construction industry enterprises and institutions of higher education such as the architecture faculty of

Szent István University, which is relocating three of its departments to the area.

Located between the Danube and the highway connecting Szentendre with nearby Budapest, and set amidst a number of existing buildings due to be refurbished in a future development stage, the ÉMI Construction Knowledge Center serves as a lighthouse project to attract other businesses that specialise in low-energy construction and engineering solutions to the area. Making the most of the oddly shaped plot, architects Antal Puhl and Péter Dajka devised a sinuous plan for the three-storey office building. Three circulation cores divide the volume into separate wings while doubling as full-height, transparent entrance halls. Based on a regular grid of columns and varied in their dimensions, the different units offer great flexibility in fur-



“THE NEW OFFICE BUILDING PARTLY OPERATES AS AN INCUBATOR HOUSE. THE INTENTION IS TO CREATE A SUPPORTING ENVIRONMENT THAT REDUCES THE RISKS OF BUSINESS FAILURE IN THE CASE OF YOUNG ENTERPRISES.” PUHL AND DAJKA ARCHITECTS

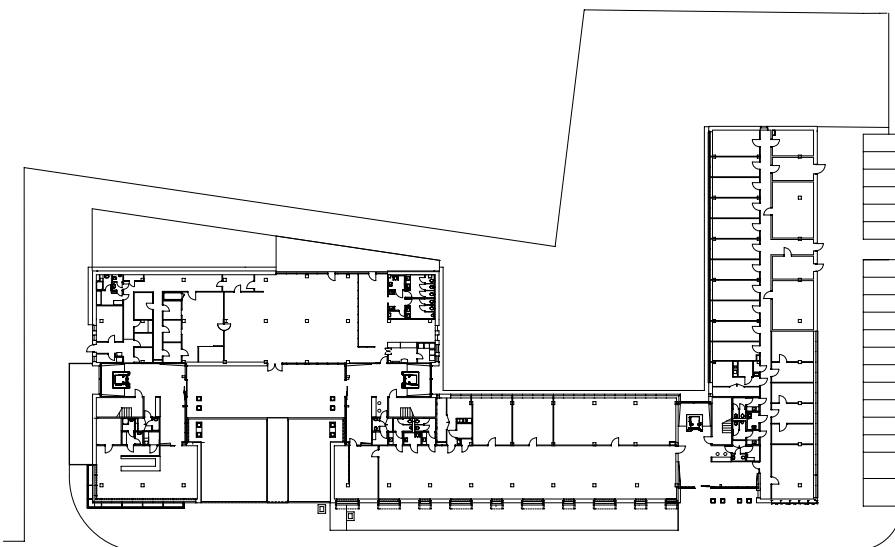

Ground floor 1:1000

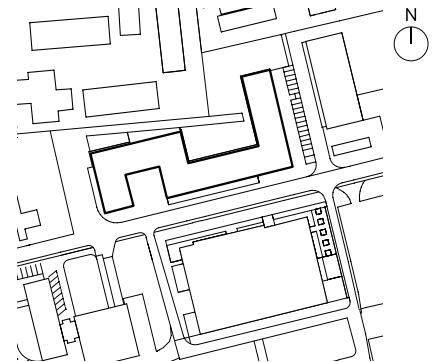

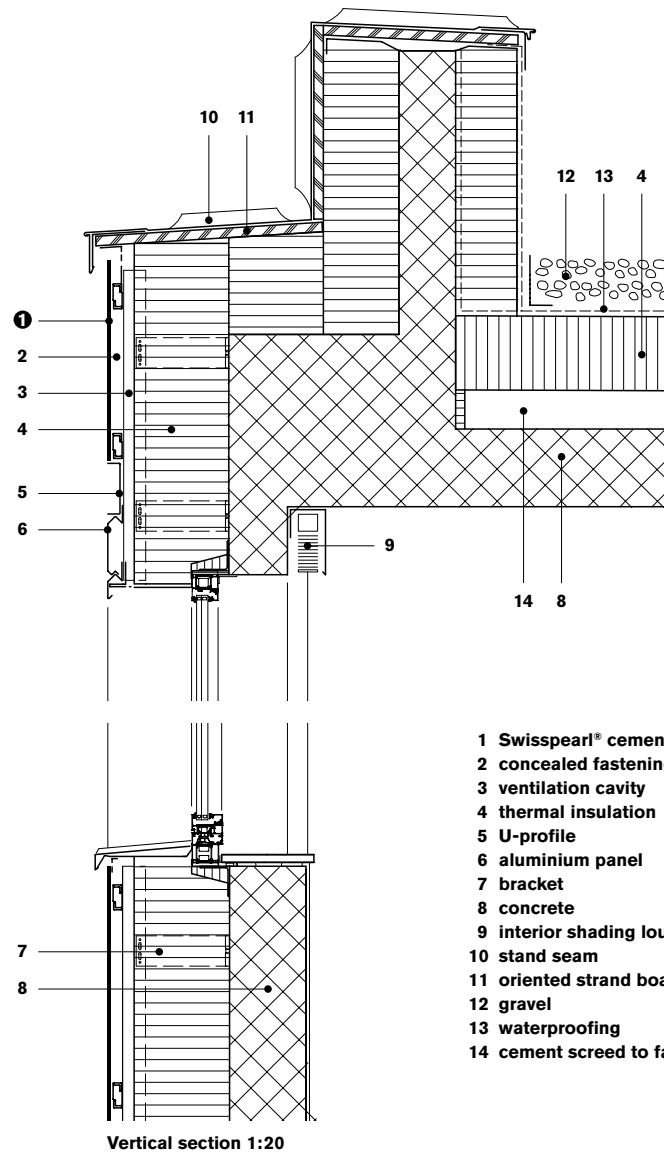

- 1 Swisspearl® cement composite panel 12 mm
- 2 concealed fastening parts
- 3 ventilation cavity
- 4 thermal insulation
- 5 U-profile
- 6 aluminium panel
- 7 bracket
- 8 concrete
- 9 interior shading louvres
- 10 stand seam
- 11 oriented strand board
- 12 gravel
- 13 waterproofing
- 14 cement screed to fall

Vertical section 1:20

“THE ROOF OF THE BUILDING IS SEEMINGLY SUPPORTED BY SIX UNIFORM WALLS THAT WERE GIVEN A WHITE SWISSPEARL SHELL.”
PUHL AND DAJKA ARCHITECTS

Location Industrial park, Szentendre, Hungary
Client ÉMI Ltd., Budapest, Hungary
Architects Puhl and Dajka Architects Ltd, Szentendre, Hungary
Building period 2012–2013
General constructor Épkar Zrt, Budapest, Hungary
Façade construction GHM Plusz kft, Budapest, Hungary
Façade material SWISSPEARL® CARAT, Onyx 7090; Special colours Black, Red and Orange
Interior material SWISSPEARL® CARAT, Onyx 7090

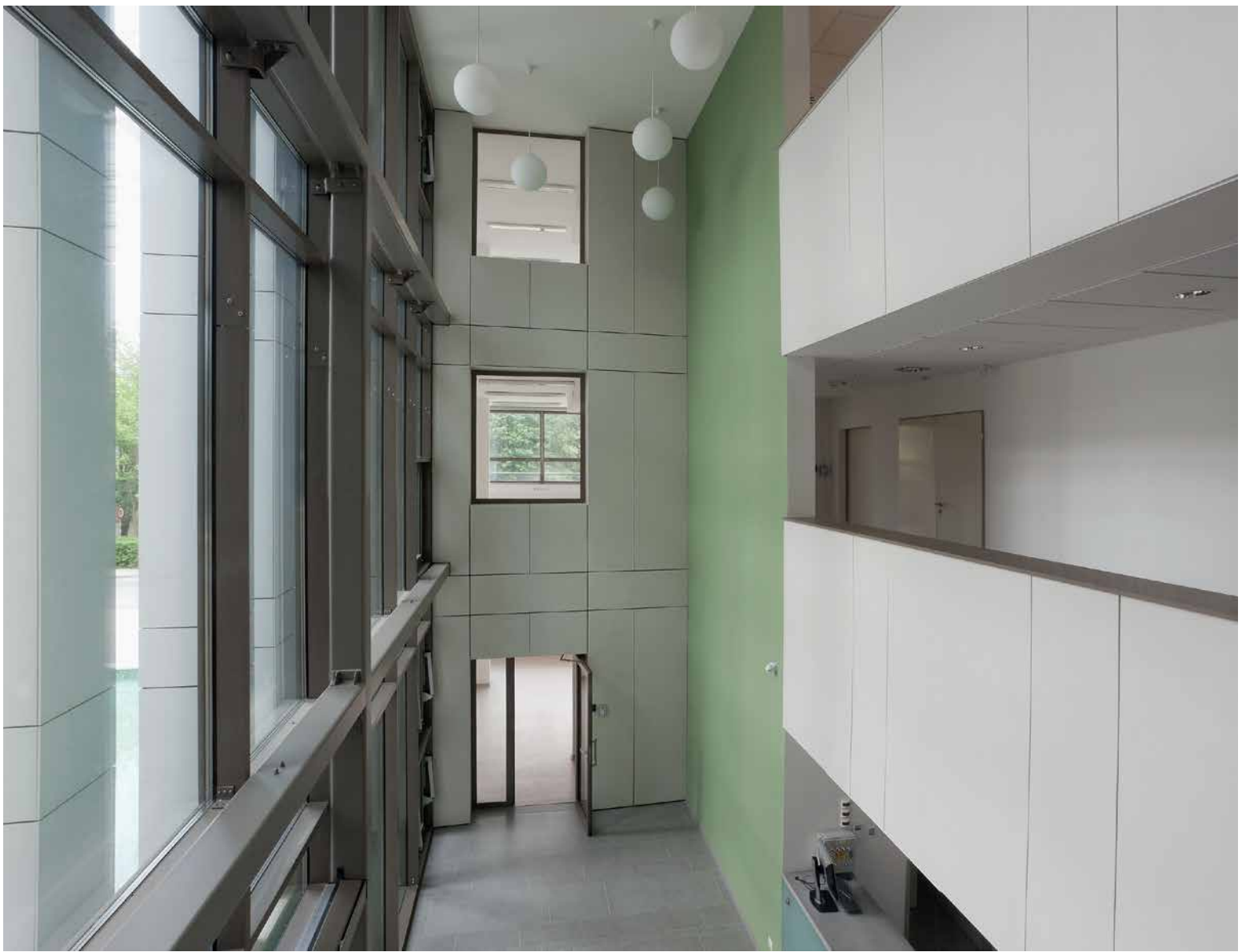

“IN PLANNING THE ENERGY CONSUMPTION OF THE BUILDING, WE ASPIRED TO THE MINIMUM AND WORKED IN ACCORDANCE WITH THE GERMAN REGULATIONS FOR A PASSIVE HOUSE.” PUHL AND DAJKA ARCHITECTS

nishing and subdividing the office floors and will thus be capable of meeting the changing demands of the targeted start-up companies. All three wings are accessed from the south, two via a forecourt that is largely covered by an artificial pond and features an eye-catching shade sail canopy.

True to its designation as a showpiece for energy efficiency, the design of the building was essentially developed in compliance with the German passive house standard. Sustainable features include a partial green roof and integrated solar panels as well as a sophisticated building energy management system and the use of renewable energy sources and recycled insulating materials. The façades are composed of brown metal curtain-wall sections framed by ventilated white Swisspearl-clad walls that turn into colonnades in the

entrance areas. Boasting a 25 cm insulation layer and tilted windows for better heat protection, the envelope plays a key part in reducing the building’s ecological footprint. *Patrick Zamariàn*



Multi-purpose Centre, Žabčice, Czech Republic

Complementary Colour Scheme

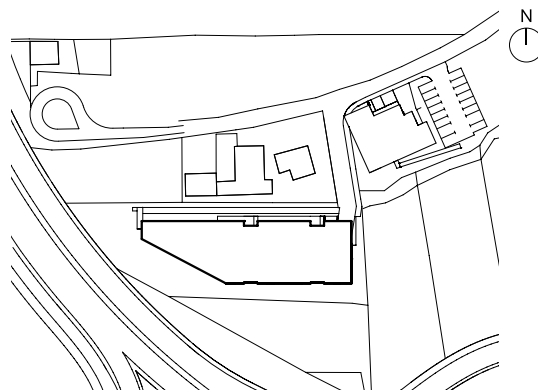

This multifunctional centre is a wood structure with a rear-ventilated Swisspearl façade. The Swisspearl saturated colour panels are fastened with rivets in the same tone to an aluminium substructure.

Architecturally, the new building fits into the southern Moravian village of Žabčice because the project respects the previous arrangement of the houses on the site. Building form and roof angles are oriented toward the original buildings. In the floor plan, the new structure is girded on three sides by an atrium. All the important local services are on the ground floor, such as shops, small businesses and offices, including the community administration offices. The guest rooms of a pension are accommodated on the first floor under the angled roof.

Two towers form compositional accents to the storage tracts. The large tower on the east side of the structure includes the main entrance and forms a passage to the pedestrian zone. A restaurant is tucked into the smaller tower on the south side. The façade panels of the tower are finished in a very pale green, while complementary green tones spread out over the remaining façade. Only the dark gold panels of the atrium, set back on the ground floor, provide a visual contrast. *mh*

The light green tone of the tower stands out among the complementary green tones of the remaining façade, while the dark gold panels of the atrium provide a contrast.

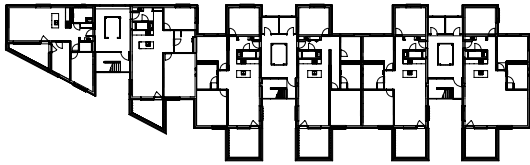

First floor 1:1000

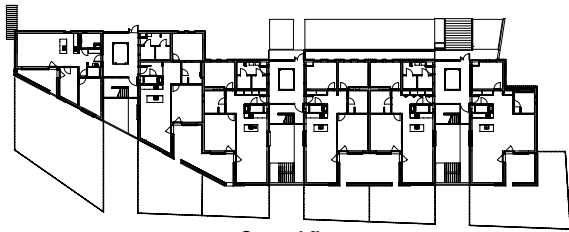

Ground floor



Location Kopeček, Žabčice, Czech Republic
Client Town of Žabčice, Czech Republic
Architect Jan Mertlík, Prag, Czech Republic
Building period 2012–2013
General contractor Imos Brno a. s., Brno, Czech Republic
Façade construction Primaizol – Stanislav Hájek, Kutná Hora, Czech Republic
Façade material SWISSPEARL® CARAT, Jade 7050, 7051, 7052 and Topaz 7073

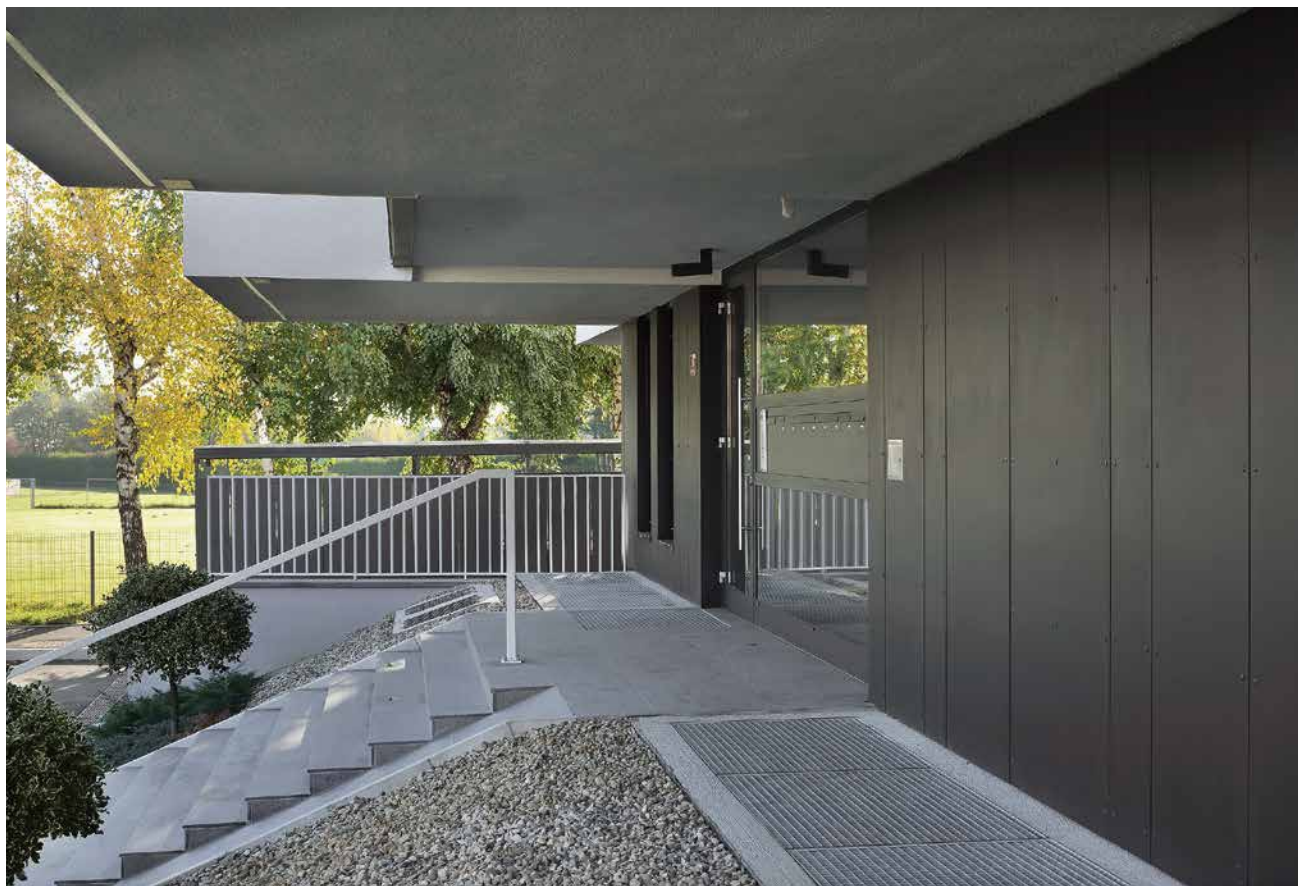

Slovenia – Accentuated entrance

The two Habakuk residential buildings are based on a modern design approach with the guiding principles of quality of living, energy efficiency, and an efficient mix of personal and social structuring of residents. Quality of living is the dominant principle of the multi-storey housing located on the southern outskirts of the town of Maribor where it joins the Pohorje Mountains and comes into contact with nature and the surrounding countryside.

The architecture of the residential flats, designed as a ‘town wall’ on the north side, reflects the urban street image. On the south side where it borders on the slopes of the mountains, it merges with the landscape with its open terraces and balconies to create a varied and dynamic structure. The floor plan and the arrangement of the flats ensure a mixture of both personal and social communication among the residents, thus fulfilling their specific wants and needs.

Three separate entrances with an outdoor staircase and lift are placed between the four storeys. Each entrance leads to eight flats with individual entrances, also with a staircase and a lift, ensuring a high level of privacy for the residents. The fully white façade of the upper floors is insulated using 15 cm-thick heat insulation and a final rendering of plaster. In contrast, the façade of the ground floor is partially clad with black Swisspearl cement composite panels to accentuate the entrances. *Styria*



Housing Habakuk, Maribor, Slovenia

Location Spodnje Radvanje, Maribor, Slovenia

Client AJM d.o.o., Pesnica pri Mariboru, Slovenia

Architects Styria arhitektura d.o.o., Maribor, Slovenia

Building period 2007–2012

General contractor and façade construction AJM d.o.o., Pesnica pri Mariboru, Slovenia

Façade material SWISSPEARL® REFLEX, Black Velvet 9221

Publisher

Eternit (Schweiz) AG, CH-8867 Niederurnen, Switzerland
phone + 41 (0)55 617 11 11, fax + 41 (0)55 617 12 71
info@swisspearl.com, www.swisspearl.com

Editor Michael Hanak, Zurich, Switzerland

Advisory Board Christine Dietrich, Head of Architecture,
Niederurnen

Detail plans Deck 4 GmbH, Zurich

Translations Beverly Zumbühl, Zurich

Design Bernet & Schönenberger, Zurich

Proofreading Jacqueline Dougoud, Zurich

Printed by Südostschweiz Print AG, Chur, Switzerland

Photos

BDE Architekten GmbH, Oliver Erb, Winterthur (p. 2)

John Edward Linden, Woodland Hills (p. 3)

Jürg Zimmermann, Zurich (pp. 4-9, 22-31)

Tom Jersø, Copenhagen (pp. 10-15)

Leif, Nuuk (pp. 16-21)

Sandro Lendler, Zagreb (pp. 32-39)

Simon Wood, Sydney (pp. 40-43)

Meraner-Hauser Photostudio OHG, St. Michael/Eppan (pp. 44-47)

Claes Westlin, Malmö (pp. 48-49)

Fernando Guerra, Lisbon (pp. 50-55)

Szabó Béla, Ótvevény (pp. 56-61)

Roman Franc, Brno (pp. 62-63)

Miran Kambič, Radovljica (p. 64)

Print run 12,000

The magazine Swisspearl Architecture is distributed exclusively
by authorised distributors in 49 countries on 5 continents.

ISSN 1661-3260

The contents of this magazine are the responsibility of the authors
concerned. Drawings kindly transmitted by the architects
correspond to the design phase; detail plans were only reworked
for greater legibility. Neither the editor nor Eternit (Schweiz) AG
checked the constructive accuracy of the drawings.

Except for Carat Onyx, Amber and Planea shades, all cement
composite panels Swisspearl® Carat, Reflex, Xpressiv and Nobilis
are only manufactured in Switzerland by Eternit (Schweiz) AG.

This magazine and all its contributions are protected by copyright.



- Australia** Sonya Perica Residence, Sydney
- Croatia** House GV-17, Sveti Martin na Muri
- Czech Republic** Multi-purpose Centre, Žabčice
- Denmark** Common Public Housing, Copenhagen
- Greenland** Pisissia Residence, Nuuk
- Hungary** ÉMI Construction Knowledge Center, Szentendre
- Italy** House M2, Bozen
Residential Apartment Blocks, Brescia
Semi-detached Houses, Uboldo
- Portugal** Single-family House, Parede near Lisbon
- Sweden** House Hindås, Gothenburg
- Switzerland** Casa Montarina, Lugano